

CONTRA COSTA COLLEGE Master Plan

03-07-2008

Extended through 2022

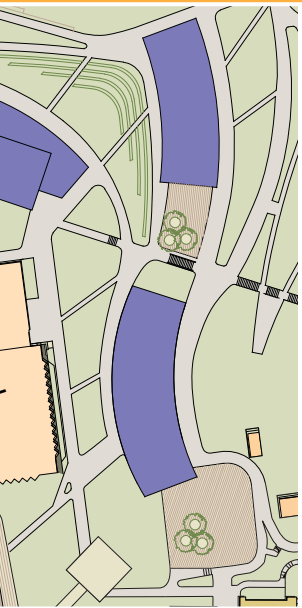

PERKINS
+ WILL



April, 2020

CONTRA COSTA COMMUNITY COLLEGE DISTRICT

CONTRA COSTA COLLEGE 2008 FACILITIES MASTER PLAN

APRIL 2020 ADDENDUM:

Contra Costa College 2008 Facilities Master Plan (FMP) was developed to guide and look forward 15-20 years and it was designed to be flexible and subject to adjustments. Recognizing that not all recommended capital improvements can take place at the same time, the FMP was developed with five phases of implementation over the approximate life of the plan. As part of planning for the Measure E bond, the college reviewed projects in the Facilities master plan for their needs and adjusted the phasing priorities in light of changes that were encountered since 2008. In 2013, the District and College leadership discussions informed the decision to utilize 2008 Facilities Master Plan as a basis of future capital improvement planning with input from Colleges on priorities. Additional analysis and discussions led to completion of the 2016 Measure E Implementation Plan for each college and formed the basis of the Measure E bond program.

Projects identified in CCC's FMP are currently still in the process of being implemented as part of the District's remaining 2006 Measure A and 2014 Measure E bond program. As the FMP was developed with multiple phases of implementation over the duration of the plan, the 2006 Measure A capital improvement program helped build out the first planning phase. The 2014 Measure E capital improvement program is focused on execution of later planning phases of the campus plan. The results of these capital improvements programs have begun to remarkably change and transform CCC. These improvements will continue over the next several years under the 2014 Measure E bond.

In order to align CCC's FMP planning horizon with the current and future projects under the 2014 Measure E bond implementation timeline, CCC FMP planning horizon is extended in this addendum from 2017 to 2022. Facilities new master planning efforts will be underway in 2020 through 2021 as CCC's updated Facilities Master Plan will respond to the college's updated Educational Master Plan. The expected planning horizon of the upcoming updated Facilities Master Plan is ten to fifteen years.

This addendum was reviewed and approved at the Chancellor's Cabinet meeting in April, 2020.

1.0 Executive Summary

2.0 Introduction

- 2.1. Basis for Master Plan Investigation
- 2.2. Project Overview
- 2.3. Project Goals and Objectives
- 2.4. Review and Approval Process
- 2.5. Master Plan Participants

3.0 Site Analysis

- 3.1. Building Seismic Assessment Summary
- 3.2. Site Constraints & Existing Conditions
- 3.3. Site Environmental Issues
- 3.4. Site Survey
- 3.5. Site and Landscape Conditions
- 3.6. Site Infrastructure

4.0 Master Plan Description

- 4.1. Master Plan Components
- 4.2. Master Plan Phasing
- 4.3. Educational Master Plan Integration
- 4.4. Space Summary
- 4.5. Vehicular, Emergency, and Fire Truck Access
- 4.6. Parking and Pedestrian Circulation
- 4.7. Site Landscape Areas
- 4.8. Site and Recreational Program Areas
- 4.9. Site Utilities Diagrams

5.0 Campus Guidelines, Systems, Standards

- 5.1. General Overview
- 5.2. Building Height and Massing Guidelines
- 5.3. Building Setbacks Guidelines
- 5.4. Building Form Guidelines
- 5.5. Building Components and Materials Guidelines
- 5.6. Code, Life Safety, and Accessibility Guidelines
- 5.7. Structural Systems
- 5.8. Mechanical, Plumbing, Fire Protection Systems
- 5.9. Electrical, Fire Alarm, Security Systems

- 5.10. AV, Information Technology Standards
- 5.11. Acoustic and Noise Control Standards
- 5.12. Sustainability Goals and Standards
- 5.13. Roadways and Drives Standards
- 5.14. Parking Standards
- 5.15. Grading and Drainage Standards
- 5.16. Planting Area Standards
- 5.17. Irrigation Standards
- 5.18. Outdoor Use Areas Standards
- 5.19. Site Furniture Standards
- 5.20. Service Area Standards
- 5.21. Wall and Fence Standards
- 5.22. Site Utilities Standards
- 5.23. Exterior Signage Standards
- 5.24. Exterior Lighting Standards

6.0 Appendix

- 6.1. Options Reviewed
- 6.2. Meeting Minutes
- 6.3. Dovetail Design Standards
- 6.4. Bay Friendly Stop Waste Checklist
- 6.5. Plant List
- 6.6. Vallier Exterior Signage Packet
- 6.7. Vallier Exterior Building Color Standards
- 6.8. LEED™ Project Checklist
- Geotechnical Report & Plates (separate document)*
- Facilities Assessment (separate document)*
- Cost Model (separate document)*
- Room Usage Analysis (separate document)*

EXECUTIVE SUMMARY

Contents and Significant Features of the Master Plan

The Executive Summary lists the individual sections and contents of the Contra Costa College (CCC) Facilities Master Plan. The Plan is organized in six separate sections described below. The planning effort was undertaken in a two-part approach described in Sections 3 – 5. The basis for that approach and planning methodology is described in the Introduction, Section 2. The phasing construction is detailed in Section 4. The separate sections and their contents include the following:

Introduction – Section 2.0

In June of 2006, the district was successful in passing Measure A, a facilities improvement bond. As a result, the college had to complete the Facilities Master Plan before funds could be released for campus projects supported by funds from this bond. Also, during the 2006-2007 academic year, the college developed an Educational Master Plan that outlined the instructional and student services needs for the next ten years. This is the first such document developed by the college in many years. It was also a major impetus behind the development of the Facilities Master Plan.

Site Analysis – Section 3.0

This section identifies site constraints and existing conditions. A summary description of site features and landscape conditions is provided. Site analysis has been on-going for many years and has included contact with federal, state and regional agencies, the city of San Pablo and utility entities. A summary analysis of known or anticipated site constraints was developed as a part of the process, and has been incorporated in the drawings and diagrams of the Facilities Master Plan.

Facilities Master Plan Description – Section 4.0

The Facilities Master Plan is consistent with the mission and goals of the college:

- A designated main campus entrance needs to be developed to improve student drop-off, wayfinding and the overall character of the college.

- Campus facilities need to be modernized to improve the appearance, ambience and the efficiency of the physical plant.
- It is critical that the seismic retrofitting required for many buildings is completed while not detracting from the ambience of the learning environment.
- As new facilities are constructed and existing facilities are modernized, it is imperative that these facilities do not conflict with the integrity of the existing campus architecture.
- Study areas designed to encourage collaborative learning in informal ways are desired in strategic locations throughout the campus.
- Building, pathway and street signage is needed to reduce the difficulty the students experience in finding their way on campus.
- ADA accessibility is a challenge due to the gentle rolling topography and uneven terrain of the campus site.
- Smart classroom technology is needed to ensure that teachers have access to the variety of instructional delivery options.
- Classroom size needs to be uniform and conducive to supporting collaborative learning in the classroom.
- Science and other instructional labs are antiquated and too small to accommodate future student demand.
- The anticipated demand in the allied health area will require multiple labs to accommodate the programs in need of the same.
- The athletic facilities are in need of significant renovation and scheduled maintenance to ensure the safety of students and student/athletes.
- The significant lack of storage space needs to be addressed in a comprehensive manner.
- The mechanical and HVAC units in many buildings need to be replaced.
- Landscaping throughout the college should have a consistent theme, color palette and building materials.

- The campus standards for furniture, fixtures and equipment needs to be employed when renovating or constructing facilities.
- All construction projects on the campus must be sensitive to the environment and designed to be energy efficient.
- Create an educational outreach center in the Pinole-Hercules area. This center will allow for college classes to be offered in the northern part of the service area.

The Facilities Master Plan also reflects key building relationships to other buildings and to open space. Circulation patterns for vehicles and pedestrians are shown within the document as well, including locations for bus, service, emergency vehicles and parking.

Finally, the landscape and utility infrastructure, including outdoor uses and open space requirements, are also depicted in the document.

Campus Guidelines, Systems and Standards – Section 5.0

Design guidelines are used to define architectural character, construction materials, mechanical and other systems. These guidelines will apply to the Phase I construction and to all subsequent construction. They are described in detail to insure that subsequent modernization projects meet or exceed these standards.

Development systems and standards for the campus buildings, site planning, signage and lighting also are presented in Section 5. The purpose is to ensure the development of a cohesive campus consistent with the goals of the Facilities Master Plan – both now and in the future as the campus grows. Equally important is for the campus to have meaningful relationships to the surrounding neighborhood.

EXECUTIVE SUMMARY

Contents and Significant Features of the Master Plan

Illustrative Plan

The Illustrative Plan on page 5 depicts the scope of the Phase I & II campus build out. The plan is informed by the strategic considerations and investigations described in this document. A complete description of the planning concepts and campus components is provided in Section 4.

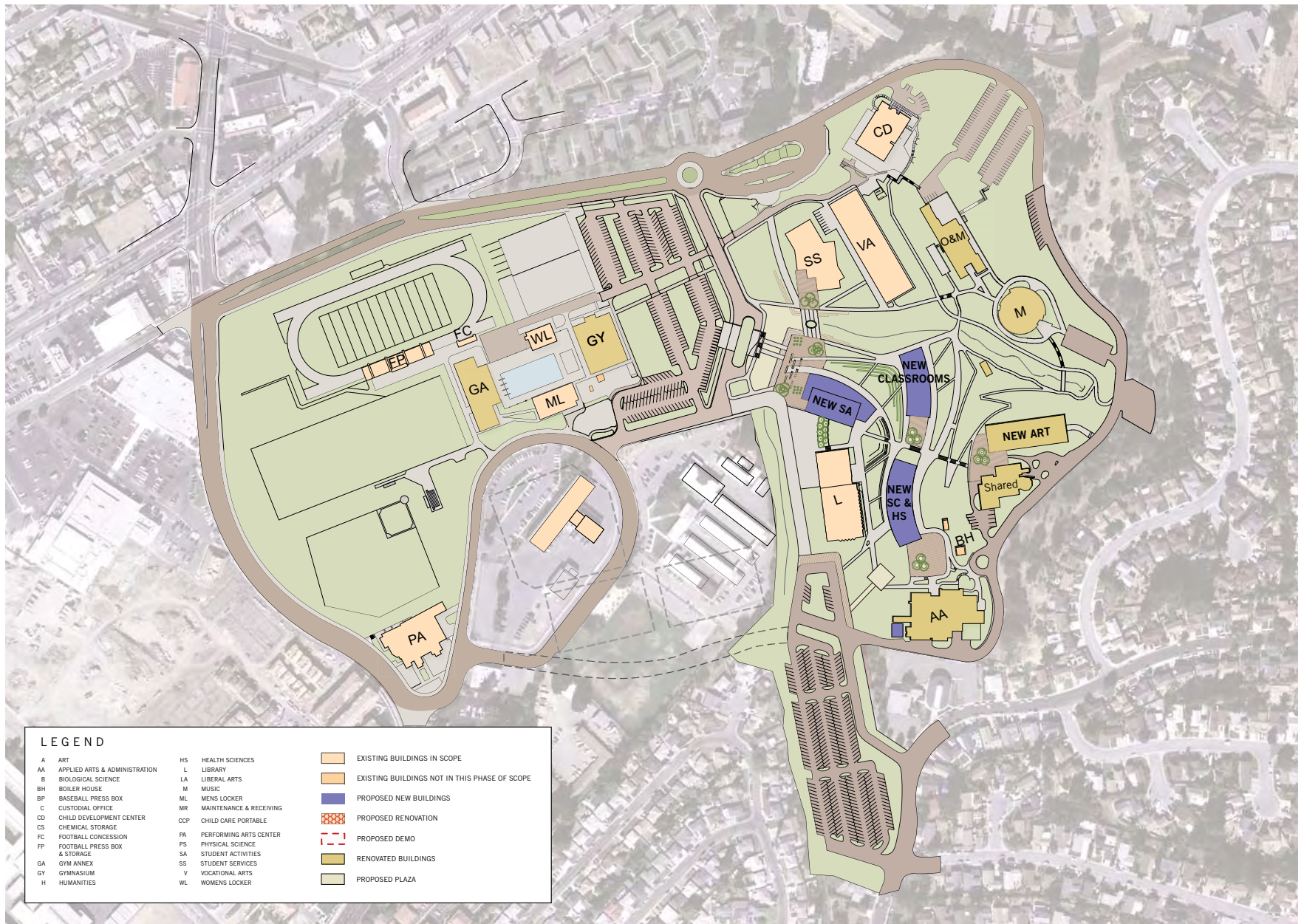

INTRODUCTION

2.1. Basis for Master Plan Investigation

Basis for Master Plan Investigation

The Facilities Master Plan was needed to respond to the passage of the Measure A bond measure in June of 2006. This facilities bond will provide funds to modernize and construct buildings at all three colleges and the three outreach centers. At Contra Costa College, the bond funds will help to address long-standing facilities needs while overcoming the many problems presented by the site. The gentle rolling hill topography, the age of the facilities, the site's proximity to the Hayward fault and the infrastructure needs combine to make modernization of the campus facilities a real challenge.

The goal of the Master Plan was to understand the influence of these various elements and to develop a phased, long-term plan for the campus to implement. The plan also provides the analysis of the seismic retrofit needs and costs so that State funds could be requested to ameliorate the site's seismic issues.

Project Scope and Conditions

The project was divided into two-major phases: Data Collection and Master Planning. In the first phase, the goal was to collect information about the campus buildings relative to the following:

Data Collection

In the data collection and analysis phase, the following information was collected in preparation for writing this plan.

- Architecture: accessibility, building condition assessment, classroom usage analysis
- Civil: condition assessment of underground utilities including sewerage systems, water, gas and electrical; campus circulation and road system evaluation
- Structural: assessment of need for seismic rehabilitation and methodology for achieving seismic improvements
- Mechanical/Electrical/Plumbing (MEP): building condition assessment

- Geotechnical: compilation of campus geotechnical records; review of record information with the California Geologic Survey (CGS); trenching investigations to determine existence of faults and to 'clear' sites for construction

The results of the data collection phase of the project are bound in a separate document for reference.

Master Planning

In the Master Planning phase, the information from the data collection phase was used to determine where development, both long- and short-term, should occur on the campus given the geotechnical site conditions. Additionally, the Master Plan considered the goals of the campus, the Educational Master Plan and the information on facility condition.

Alquist-Priolo (AP) Zone

The AP Zone covers most of the main campus with the exception of a few buildings on the upper perimeter road. Construction is limited in this zone by State Law to voluntary seismic improvements for qualifying buildings. While the campus had invested in trenching over time, a better understanding of the campus geotechnical conditions and educational program requirements needed to be brought together into a cohesive long term plan that considered both. In addition, extensive additional trenching was necessary before a final plan could be developed.

Bond funds must be developed for educational purposes

The goal of the College is to utilize the bond funds for improvements and renovations in educational programs as well as new construction projects. Additional State funding may be allocated for seismic remediation programs.

Other uses for the bond funds that can be considered must be educational in nature or must directly support the college's educational mission.

Project Programs

The programs at the college use approximately 234,094 assignable square feet (ASF). An area breakdown by building is provided in Section 4.4. The following programs are represented at the campus, although some may be temporarily displaced:

Academic

- Academic Skills
- Administration of Justice
- African American Studies
- Anthropology
- Art
- Automotive Services (including Refrigeration and Appliance Repair)
- Biological Sciences (including Biotechnology)
- Business (including Real Estate)
- Chemistry
- Computer and Communications Technology
- Computer Information Systems including (Business Office Technology)
- Computer Science (including High Performance Computing and Robotics)
- Cooperative Education
- Cosmetology
- Counseling
- Culinary Arts
- Dental Assisting
- Drama
- Early Childhood Education (including Education)
- Early Learning Center
- Earth Sciences
- Economics
- Engineering (including Architecture, Drafting)
- English
- English as a Second Language
- Foreign Languages
- Geography
- Geology
- Graphic Communication
- Health and Human Services (including Medical Assisting & Emergency Medical Sciences)
- History
- Humanities (including Philosophy)
- Journalism
- La Raza Studies
- Library Studies
- Mathematics
- Media and Communication Arts
- Music
- Nursing
- Physical Education (including Health Education)
- Physical Education – Intercollegiate Athletics
- Physics (including Astronomy)
- Political Science
- Psychology
- Social Sciences (including Economics, History, Political Sciences, Psychology and Sociology)
- Speech

INTRODUCTION

2.1. Basis for Master Plan Investigation

Administrative & Student Support Services

- Admissions and Records
- Assessment
- Bookstore
- CalWorks
- DSPS
- Financial Aid
- Transfer and Career Center
- Matriculation
- Communication, Liberal Arts, Skills and Services Division
- Library, Allied Health, Vocational Training and Athletics Division
- Natural , Social and Applied Sciences
- Business Office
- Buildings and Grounds
- Dean of Students
- Dean of Instruction
- Dean of Economic Development
- Dean of Planning, Research and Student Outcomes
- Office of the President
- Office of the Vice President of Academic and Student Affairs
- Police Services
- Technology Services
- Student Activities

Project Phasing

The Master Plan includes a phasing plan to sequence construction in order to allow educational programs to stay in operation while campus improvements are underway. A detailed description of the proposed 5-phases is included in Section 4.2

Project Costs

The following budget was prepared to align costs with the proposed project phasing and the specific modernization and construction requirements of the campus.

Construction costs for seismic renovation work will be evaluated based on guidelines determined by the State and the costs outlined in the Cost Model. Some negotiation with the State may be required depending on the cost and scope of each proposed renovation.

Construction costs (in thousands)

Phase 1	\$ 43,043
Phase 2A	\$ 53,435
Phase 2B	\$ 33,752
Phase 3	\$ 38,945
Phase 4	\$ 3,923
Phase 5	\$ 3,145
TOTAL	\$ 176,244

Escalation based on the phasing schedule has been included above and is described in the Cost Model which is available as a separate document.

Other Project Costs

Soft costs are not outlined in the construction costs above but would be included in overall Project Costs. These items include but are not limited to design and construction documentation, furniture, equipment, permitting fees, geotechnical engineering, and hazardous materials consulting. A complete list of exclusions can be found in the Cost Model.

Contra Costa Community College District

Contra Costa Community College District was established on December 14, 1948, with boundaries nearly identical to those of Contra Costa County. There are three colleges in the district: Contra Costa College (San Pablo), Los Medanos College (Pittsburgh), and Diablo Valley College (Pleasant Hill), which also operates the Center for Higher Education (San Ramon).

Contra Costa College

Contra Costa College was the first of the three colleges in the district to be established. Originally named Contra Costa Junior College, West Campus, it began in 1949 at the old Kaiser Shipyards in Point Richmond. The first classes started February 14, 1950, with a beginning enrollment of 500 students. The campus consisted of an assortment of wooden buildings, no grass, lots of blacktop, and a parking lot with a railroad line running through it. It also had views of Point Richmond's hills and of the ships moving through the adjacent canal.

Planning began for the new campus, an 83-acre site in the rolling hills overlooking San Pablo Bay. In 1956 the college moved to its present location. Construction continued throughout the 1960s, yielding buildings for Physical Education, Music, the Library, Student Union, Vocational Education and administrative headquarters. By 1966, the college had 10 permanent buildings in addition to 15 temporary structures. The Planetarium and Physical Sciences Annex were ready for use in 1975. The Health Sciences Building had opened the year before.

The college is a comprehensive community college that offers instruction for students interested in transferring to four-year institutions, vocational and career training, basic skills instruction, avocational and recreational classes and fee-based community service workshops and seminars.

The college also provides students with a wide array of student support services to assist them in accomplishing their academic goals.

Some significant dates in the college's past include February of 1976 when \$2.5 million was approved for construction of the Applied Arts Building. In 1980, the new Performing Arts Center opened, and in 1982, the Applied Arts Building opened for use. On February 14, 2000, Contra Costa College celebrated its 50th anniversary.

Service Area

Contra Costa College serves the cities and municipalities of Richmond, El Cerrito, San Pablo, Pinole, Hercules, Kensington, Crockett, Rodeo, El Sobrante and North Richmond. The total population for these communities was 232,047 (2000 census).

According to the Association of Bay Area Governments' (ABAG) 2007 Projections Report, the East County area will grow much faster than Central and West county areas. However, projected household growth in the CCC service area (of over 8,000 households) will have a positive impact college enrollment in the future. By the year 2030 the City of Richmond will experience a 21% increase in population. Much of Richmond's growth will be related to population increases around transportation hubs, denser local neighborhood developments, and the development in the Marina and Richmond Parkway areas. Also some growth is projected for the Pinole/Hercules area thus suggesting the potential for an increase in enrollment at the college.

West County continues to be far more ethnically and racially diverse than the county at large. The 2000 census indicated that the population of West County is approximately 29% white, 25% African American, 25% Hispanic and 18% Asian. In addition, West County communities tend to have lower rates of employment, lower median household income, lower median home values, and lower home ownership rates than does the remainder of the county, and the San Francisco Bay Area in general.

Student enrollment trends at CCC have fluctuated from a high of 10,668 Fall 2002 to a low of 7,667 Spring 2005. Based on nine semesters of data, the average student retention was 82%. The ethnic distribution of CCC's student population reflects the diversity of CCC's service area.

A large proportion of disadvantage and underprepared students live in the area and attend the college. Hence, programs such as Academic Skills and English as a Second Language are attracting a high number of students.

INTRODUCTION

2.2. Project Overview - Background and History

Methodology

The CCC Master Plan was conducted in two separate phases. Identified these are as follows:

Data Collection

The participants in this phase of the project included the design team of Perkins + Will architecture, BKF civil engineering, Dasse Design structural engineering, Alfa Tech mechanical, electrical and plumbing, Davis Langdon cost consulting. Also, included were the district contract consultant firms of Parsons Brinckerhoff (PB) – bond and construction management and Kleinfelder Geotechnical Engineering. The following approach was used to gather the data:

- Investigate Site Constraints (easements, entitlements, engineering, etc)
- Compile historical geotechnical information; identification of additional geotechnical investigations; review with CGS
- Confirm jurisdictional authority and agency requirements
- Investigate condition of utilities and buildings
- Develop structural rehabilitation requirements
- Assess accessibility and code requirements
- Analyze room usage

Result:

- Optimal Site area(s) for development identified
- Informed Site Development
- Guidance for Site and Building Design

Planning Process

Also intimately involved in the development of the Facilities Master Plan were key members of the college community. Data was presented to this group as it became available and decisions needed to be made. The group had bi-weekly and special meetings to discuss issues related to the data as it was being collected. Key participants were the President, the Vice President of Academic and Student Affairs, the Manager of Buildings and Grounds, the campus Project Manager, the President's Cabinet and the membership of the College Council.

Approach:

- Investigate Program Requirements and Institutional Goals
- Incorporate Economic and Environmental Criteria
- Review design with regulatory agencies
- Develop Plans in collaboration with College and District
- Cost Modeling

Result:

- Alternate Campus Plans Investigated
- Validated Campus Plan Selected

Direction from College

Goals and objectives were developed through the shared governance process adopted by the college. Presentations were made to the President’s Cabinet and to the College Council to encourage input on the appropriateness of the goals and objectives. All members of the college’s constituencies were represented at these meetings.

The Facilities Master Plan is guided by goals and objectives established with these participants. “Goals” are those over-arching concepts that influence conceptual development. “Objectives” describe specific aspects of physical development.

The goals and objectives were developed in alignment with the Contra Costa College Mission Statement

Contra Costa College Mission Statement

As a public community college that serves an urban community rich in diversity, the mission of CCC is to offer instruction within a comprehensive curriculum and to provide student services to ensure opportunities for:

- effective student learning that leads to successful achievement of educational goals through completion of developmental, certificate, degree or transfer programs;
- acquisition of knowledge, skills and abilities pertinent to lifelong learning and gainful employment in the global community;
- student success verified by a process of assessment and improvement.

Goals and Objectives of the Facilities Master Plan

The Master Plan addresses general requirements for the planning, location, and sequence of construction for Contra Costa College. That five-part process described in the following section identifies and supports these goals:

- Create identity and clear entry for the campus and improve campus image to attract students.
 - o Create a prominent visible entry that conveys a sense of arrival.
 - o Develop a quad with distinguished features (Campanile/Sather Gate).
- Signage – building & way finding
 - o Establish logical and consistent signage throughout the campus that is visible and easy to read.
- Construct new facilities and modernize existing ones so that they are compatible with existing campus architecture.
- Improve traffic circulation around campus and restore two-way circulation to the perimeter road
 - o Improve pedestrian circulation
 - o Create safe and clearly marked drop-off points
- Integrate Middle College Students with campus – not segregated
 - o Provide space for a study hall and work space for Middle College students & faculty.
- Improve ADA access.
 - o Create path of travel (P.O.T.) and plazas that are ADA accessible and repeated throughout the campus.
- Equip every classroom with “smart classroom technology”.
- Provide a meeting place for community (150-200 people) as well as meeting spaces of varying sizes for College Council, Academic Senate (25-50 people).
- Provide classrooms environments to support emerging focus from teaching to learning centered environments.
- Create areas for group interaction and collaborative learning opportunities.
- Create student study areas in all buildings.
- Faculty office space needs to be expanded to accommodate the need to meet with students. Also, there is a need for breakout or small conference size rooms to allow for faculty gatherings, faculty lunch and collegial interaction.

INTRODUCTION

2.3. Project Goals and Objectives

- Develop standards for furniture, fixtures and equipment.
- Capitalize on the current appeal of the campus.
 - o Maintain the urban oasis feel with the mature growth of plants, trees, etc.
 - o Maintain & enhance natural environment as education experience-creek, trees, wild turkeys.
 - o Enhance outdoor spaces build on use of natural environment as educational experience
- Programs need space to enhance their operation.
- Reorient the campus so that administration and student services are more contiguous in their location.
- Ensure and enhance the safety aspects of the campus grounds, pathways and buildings.
- Provide operable windows and doors for individual control.
- Energy efficient systems and implement sustainability.
 - o Consider alternate energy systems like solar – part of design of (N) buildings.
 - o Zone HVAC controls.
- Create sufficient storage space to allow for the removal of cargo storage containers.

Regulatory Agencies and Review Entities

The campus site falls outside the municipal jurisdiction of the Cities of Richmond and San Pablo. Site analysis has been on-going and has includes or recommends contact with the following agencies:

Federal Agencies

- US Army Corp of Engineers (USACE)

State Reviews

- California Department of Fish & Game (CDF&G)
- Division of the State Architect (DSA)

Regional Reviews

- Contra Costa County Flood Control District
- Contra Costa County Water District
- Contra Costa County Mosquito & Vector Control District
- AC Transit
- West County Waste Water District
- Contra Costa County Water Quality Control Board

Cities of Richmond and San Pablo Reviews

- Public Works
- Parks & Recreation
- Fire Departments

Utilities

- Sewer
- PG&E
- Trash / Recycling
- AT&T

INTRODUCTION

2.4. Review and Approval Process

Primary Participants in Development of the Plan

The process of assessment and evaluation has been a collaborative undertaking, by the design team, with Contra Costa Community College District faculty, administrators, planning and support staff. Principal participants in the overall planning and review effort are:

Contra Costa College Administration

- McKinley Williams, President
- Carol Maga, Vice President
- Terence Elliott, Academic Senate President
- Bruce King, Maintenance & Energy Svcs, City of El Cerrito
- Mercy Pono, Classified Senate President
- Tim Clow, Senior Dean, Research and Planning
- Mariles Magalong, Director/Business Services
- Raja Hudson, President of the Associated Student Union
- Members of the College Council

Contra Costa Community College District Facilities and Operations

- Jack Schaffer, Project Manager
- Teresa Greenwell, Project Manager Construction
- Kindred Murillo, Assistant to the Chancellor
- Georgette Stewart, Project Controls Specialist

Planning, Design and Engineering

Perkins + Will, Inc.

Architecture and Planning
185 Berry Street, Suite 5100
San Francisco, CA 94107
(415) 856-3000

Karen Cribbins-Kuklin, AIA, Project Principal
Susan Seastone, Project Manager
Nick Seierup, Design Principal
Hyuek Rhee, Project Designer
Carolina Ramirez, Graphics Designer
Eileen Tse, Administrative

Conger Moss Guillard

Landscape Architecture
500 Third Street, Suite 215
San Francisco, CA 94107
(415) 495-3070

Christopher Guillard, Principal
Kevin Conger, Principal
Jamie Phillips, Designer

BKF Engineers, Inc.

Civil Engineering
2737 North Main, Suite 200
Walnut Creek, CA 94597-2714
(925) 940-2200

Daniel Schaefer, Principal
Robert Stevens, Project Manager
Brock Roby, Project Engineer

DASSE Design, Inc.

Structural Engineering
33 New Montgomery St., Ste. 850
San Francisco, CA 94105
(415) 243-8400

Joe Sutton, Principal
Peter Wrona, Principal

Kleinfelder, Inc.

Geotechnical
7133 Koll Center Parkway, Suite 100
Pleasanton, CA 94566
(925) 484-1700

Don Gray, Principal Engineer

Alfa Tech Cambridge Consulting Engineers

Mechanical, Electrical, Plumbing & Fire Protection Engineering
120 Montgomery Street, Ste 715
San Francisco, CA 94104
(415) 403-3000

Glenn Claycomb, P.E., Principal
Philip Thwin, Electrical Engineer

Davis Langdon

Cost Estimating
343 Sansome Street, Ste 1050
San Francisco, CA 94104
(415) 981-1004

Alice Nguyen, Principal
Sam Evison, Associate

SITE ANALYSIS

3.1. Building Seismic Assessment Summary

Number	Building	Number of Stories	Year Built	Structural System	F&E Seismic Risk Rating <i>(as established by F/E Report, dated 8/4/06)</i>	Potential Fault Condition <i>(as reported by Kleinfelder)</i>	Limitation for the scope of renovation <i>(i.e. AP Zone)</i>	Life Safety Deficiencies/Hazards	Proposed Retrofit Modifications
1	Administration & Applied Arts	2	1979	Wood framing with plywood shear walls	IV	Cleared by old trenches	None	Discontinuous shear walls and insufficient drag elements.	Add new glulam beams and wood posts under discontinuous shear walls. Add drag elements.
2	Biological Sciences	1	1960	Steel framing with masonry and plywood shear walls and tension only bracing	IV	Outside AP zone	None	Inadequate shear walls, tension-only braced frames, roof diaphragms, and wall anchorage.	Add new interior shear walls, add new tension-only bracing or convert existing tension-only bracing to tension-compression braced frames.
3	Gym	1	1956	Steel beams and trusses to concrete pilasters with concrete shear walls	IV	Not cleared	Pending Fault Clearance	Inadequate roof diaphragm horizontal steel bracing, diaphragm chords, and wall-to-roof anchorage. Inadequate connection between covered walkway and gym structure.	Add horizontal steel bracing at the roof and strengthen diaphragm chord connections. Add strong-back framing at the east and west concrete walls. Strengthen walkway connections to the main structure by adding straps or holdowns.
4	Gym Annex	2	1967	Concrete framing with concrete shear walls	IV	Not cleared	Pending Fault Clearance	Discontinuous lateral load path through glazing/louvers along N/S walls. Inadequate wall-to-roof anchorage connections along E/W walls. No crossties in the high roof in E/W direction.	Add steel X braces at glazing along N/S walls. Add new full depth glulam beams to brace the concrete joists and provide an anchorage to the E/W walls. Add steel straps at the high roof area.
5	Health Center (Health Sciences)	2	1972	Wood framing with plywood shear walls	III	Cleared by old trenches	None	None	None
6	Humanities	1	1955	Wood and steel framing with plywood shear walls and steel K bracing	V	Cleared	None	Inadequate K-braced frames in longitudinal direction. No lateral bracing at exterior walls with windows. Inadequate diaphragm connection to wing walls at "dogleg" transition. Lay in tile ceilings are not secured.	Add new steel braced frames at the exterior longitudinal walls. Strengthen diaphragm connections to wing walls at "dogleg" transition. Secure lay in tiles with clips.
7	Liberal Arts	2+B	1965	Concrete pan joist framing with concrete shear walls	VI	Cleared by old trenches	None	South concrete shear wall is discontinuous and shear cracks are visible in beams supporting upper shear walls. Torsional irregularity exists at first floor due to ground floor wall configuration.	Provide new columns in the center of beams below discontinuous shear walls. Provide in-fill concrete shear walls to 4 bays at the south wall to provide a more regular shear wall pattern and mitigate torsion.

3.1. Building Seismic Assessment Summary

Number	Building	Number of Stories	Year Built	Structural System	F&E Seismic Risk Rating <i>(as established by F/E Report, dated 8/4/06)</i>	Potential Fault Condition <i>(as reported by Kleinfelder)</i>	Limitation for the scope of renovation <i>(i.e. AP Zone)</i>	Life Safety Deficiencies/Hazards	Proposed Retrofit Modifications
8	Music	1	1963	Wood and steel framing with plywood and concrete shear walls	V	Outside AP zone	None	Inadequate plywood shear walls in wood portion. Inadequate roof-to-wall anchors in concrete portion.	Add new shear wall panels to the outer ring (line C) of the building between lines 19 and 1. Add roof-to-wall anchors.
9	Physical Sciences (Natural Sciences)	1	1954/1973	Wood and steel framing with plywood shear walls and steel K bracing	V	Cleared by old trenches	None	Inadequate K-braced frames in longitudinal direction. No lateral bracing at exterior walls with windows. Lay in tile ceilings are not secured.	Add new steel braced frames at the exterior longitudinal walls. Secure lay in tiles with clips.
10	Student Association (Student Activities)	1+M	1958/1968	Wood and steel framing with plywood shear walls and steel moment frames	IV	Not cleared	Pending Fault Clearance	None	None
11	Vocational Arts	1	1957/1963	Steel framing with plywood shear walls and steel truss moment frames.	IV	Cleared (confirm with CGS)	None	None	None
13	Women's Locker Building	1	1961	Wood framing with plywood shear walls	III	Not cleared	Pending Fault Clearance	Inadequate locker anchorage	Anchor lockers to slab on grade.
13	Women's Locker Building	1	1961	Wood framing with plywood shear walls	III	Not cleared	Pending Fault Clearance	Inadequate locker anchorage	Anchor lockers to slab on grade.

Notes:

1. Fault clearances to be confirmed by Don Gray (Kleinfelder) with CGS; meeting with CGS to occur by March 1.
2. Trenching to clear, or complete clearance of, buildings will occur between March 15 – April 13.

SITE ANALYSIS

3.2. Site Constraints and Existing Conditions

Narrative Description

The following site constraints exist on campus:

Topology

The site is arranged such that the southern half of the campus lies on a flat plain situated outside of the 500 year flood zone according to FEMA Community-Panel Nos. 06003 50015D and 06003 60001E. The northern half of the campus is on a natural hillside and contains approximately 5 acres of undeveloped land area with a slope in excess of 20%.

Drainage Channels

Rheem Creek and a tributary drainage channel traverse the north and central portions of the campus, resulting in approximately 3.5 acres of land within the banks which cannot be developed. As these drainage channels convey storm water through the campus from the adjacent neighborhoods, modifications to the channels and their watershed must be carefully considered.

Easements

The West County Wastewater District (WCWD) owns and maintains the sanitary sewer mains that run through the campus from the neighboring residential area just north of the site to the sewer mains located in Mission Bell Drive. These mains are contained in 10' and 12' wide easements that are dedicated to the WCWD for maintenance and operation. Connection to, or relocation of these mains requires the notification, approval, and inspection of the WCWD. Sanitary sewer laterals connecting the campus buildings to the mains are the property of Contra Costa College.

Similarly, the natural gas mains serving the campus are owned, operated, and maintained by PG&E. Conversely, the electrical facilities on campus are served by PG&E, but are owned entirely by Contra Costa College. There are no overhead or underground electric facilities contained in easements on campus.

Except for the open drainage channels, the storm drainage system on campus is owned entirely by Contra Costa College. Similarly, the water and firewater distribution systems, after the meter and backflow prevention devices, are owned and operated by Contra Costa College.

Areas for Further Investigation**Rheem Creek**

The State of California's Environmental Information Catalog lists 1200 feet of Rheem Creek on the Contra Costa College campus as being included in an urban creek and wetlands restoration project (ID # 166) as of January 1, 2007.

Soil Corrosivity

The existing conditions survey of the campus water system indicated evidence of corrosive soils. Of the 93 water valves on campus, campus facilities personnel report that 67 are frozen, not functional, or not found. A soil investigation should be performed to determine the soil corrosivity.

SITE ANALYSIS

3.4. Site Survey

Current Status and Recommendation

Available Record Information

Currently, the available survey record information for Contra Costa College consists of the following:

- An electronic topographic survey prepared by LCC, Inc. from a 1964 aerial survey, which covers approximately 33 acres of the 83 acre campus.
- “As Built” drawings from improvement projects on campus which are on file at the CCCC District office. These do not exist in electronic format.
- Utility one-line drawings which depict a schematic layout of the campus utility systems. These drawings do not give subsurface information, nor is this information available in electronic format.

Comprehensive Base Map

A current aerial survey supplemented with topographic information is needed and would yield a base map with accurate elevations and horizontal distances for the entire campus which could then be used for planning and future construction purposes. As well, a boundary survey would be useful to determine the exact limits of Contra Costa College property and any easements that are in existence. This will be necessary for any purchase, sale, or exchange of any property with the City or neighboring property owner.

Campus Organization: Topographic Definition

The natural environment of the campus is delineated by its topographic definition. The western side of the campus is part of the alluvial plain between the Berkeley Hills and the Potrero San Pablo.

The eastern side of campus climbs into the Berkeley Hills rising 140 feet from elevation 60 at the edge of Rheem Creek to elevation 200 at the eastern property line. The two sides are separated by the creek corridor and the earthquake fault lines running north – south across the campus.

West Campus Area is part of the alluvial plain between the Berkeley Hills and Point San Pablo. This flat area has been programmed for recreational use and sports fields and presents the public face of the campus along El Portal Street, Castro Street, and Campus Drive.

The East Campus Area is a hillside separated into two terraced levels representing the Lower Hillside or Main Campus Area and the Upper Hillside.

- Lower Hillside – Main Campus Area – the Lower Hillside Area between elevations 60 and 100 contains the current quad and amphitheater and is bisected by the North Tributary of Rheem Creek. This area is defined by a transition from the steeper slope to a more gradual area and includes the primary campus open spaces.
- Upper Hillside – This Upper Hillside is defined by steep slopes and numerous stands of excellent trees. This area climbs from elevation 100 to 200 at the eastern property line.

Stream Corridors-Arboretum

Rheem Creek, a tributary of Wildcat Creek, flows from south to north across the campus, bisecting the two main areas - the hillside and the plain. The North Tributary of Rheem Creek, flows through the hillside portion of campus, separating the main campus area from the northeast side. During the 1960's the North Tributary was planned and planted as an arboretum by the Life Sciences Department and the Richmond Elks Club. Many excellent specimen trees exist today as part of the stream woodland. Restoration of the Rheem Creek and North Tributary and the Arboretum could serve as an environmental educational opportunity for college departments.

Existing Trees

In addition to the North Tributary arboretum, many fine specimen trees exist on campus.

- Oaks - A 30" Valley Oak (Quercus lobata) at the intersection of the Liberal Arts buildings
- Historic Windrows – windrows along the western perimeter and Rheem Creek buffer the prevalent easterly winds
- Palms – Canary Island Palms (Phoenix canariensis) in the quad.
- Date Palms (Phoenix dactylifera) in the arboretum
- Pines – specimen stone pines (Pinus pinea) at the corner of Mills Avenue and Campus Drive

Views

The Hillside area of campus provides excellent views west toward the San Pablo Bay and southwest toward the city of San Francisco.

Wind

Prevailing winds are generally from the bay, in an easterly direction. The impact of these prevailing winds on the use of outdoor spaces such as the amphitheater and plazas should be carefully considered. Shady areas unprotected from the wind can be uncomfortably cold on relatively mild days. Offshore breezes are generated by inland heating and cooling of inland areas, and tend to increase in the late afternoon.

SITE ANALYSIS

3.5. Site and Landscape Conditions

Program Area Constraints

Lack of clear entry and arrival onto campus.

The Campus is currently accessed at three points of entry: The main entry in the north from Mission Bell Drive and El Portal, a second entry in the west from Castro Rd. and a southern entry on Mills Avenue from Shane Drive. Existing entry points lack hierarchy and clarity.

- **Campus Drive loop road is constricted.**

Currently, the campus loop road has one-way access traveling north from Mills Avenue to the Music Building parking lot, where it becomes a two-way road for the remainder. Two-way access is not possible in the existing condition due to the constriction of the loop road at the southeast corner of the Applied Arts & Administration building.

- **Service access drive is used to cut through campus and as a student drop-off.**

- **Dead end parking lots**

Circulation through and around campus is difficult and confusing due to multiple one way parking lots which serve as part of the primary circulation

- **Entry landscapes need improvement.**

- **Pedestrian circulation lacks clarity.**

Existing pedestrian circulation is challenged by a lack of hierarchy and significant topographic changes which currently limit universal access.

- **Dispersed campus lacks a clear center and student event space.**

- **Stream corridors are not utilized as teaching environments or natural amenities.**

- **Views from the upper plazas are obstructed by structures and trees.**

LANDSCAPE CONDITIONS

-  EXISTING BUILDINGS
-  WEST CAMPUS AREA - ALLUVIAL PLAIN
-  EAST CAMPUS AREA - LOWER HILLSIDE
-  EAST CAMPUS AREA - UPPER HILLSIDE
-  STREAM CORRIDOR
-  EXISTING SPECIMEN TREES
-  VIEWS
-  WIND
-  1 LACK OF CLEAR ENTRY & CAMPUS ARRIVAL
-  2 CAMPUS DRIVE LOOP ROAD CONSTRICTED
-  3 SERVICE ACCESS DRIVE IS USED TO CROSS CAMPUS AND AS A STUDENT DROP OFF
-  4 DEAD END PARKING LOTS
-  5 ENTRY LANDSCAPES NEED IMPROVEMENT
-  6 STREAM CORRIDORS ARE NOT UTILIZED AS NATURAL AMENITIES



SITE ANALYSIS

3.6. Site Infrastructure

Site Infrastructure Description

In general, the existing utility systems at Contra Costa College are meeting the current demands from a capacity point of view. Future improvements, as proposed by the Master Plan, should be sustainable as long as these improvements represent relocations of laterals and building connections rather than increases in capacity. Ultimate capacity studies should be performed as part of any plan that results in an increase in demand.

From a condition point of view, the existing utility systems currently suffer from deficiencies that will need to be addressed in order to implement the Master Plan:

Domestic Water System

The Contra Costa College Campus is supplied domestic and fire water by four (4) points of connection to the East Bay Municipal Utility District (EBMUD) system. These connections are as follows:

1. 8" meter and backflow prevention device located on Mission Bell Drive across from the tennis courts.
2. 8" meter and backflow prevention device located on Castro Street adjacent to the Men's locker room.
3. 2" water meter on Castro Street for service to the Performance Arts building.
4. 10" fire connection on Mills Avenue across from the Maintenance Office.

A single water service loop connecting the two 8" meters provides combined domestic and fire water service to most of the campus. The 8" meters are connected to EBMUD's Central Pressure Zone. Water pressure is reported to be low in the upper campus areas. It is recommended that future water service be connected to EBMUD's Road 24 pressure zone, which currently serves the 10" dedicated fire connection on Mills Avenue, and has a higher residual pressure.

The existing water mains and laterals on campus are largely composed of asbestos cement pipe (ACP), commonly referred to as "transite" pipe. Campus maintenance and facilities personnel report that the overall condition of the transite pipe on campus is found to be poor, and that recent repairs have resulted in disintegrating existing pipe material when repairs were attempted. It should be assumed that most original water pipe material has reached the end of its effective design life.

There are currently 93 gate valves on campus used to shutoff water supply to mains and laterals when isolation is needed for construction, inspection, or emergency. Of these 93 valves, 67 are reported to be frozen, not functional, or not found. The current maintenance procedure involves shutting off the entire campus water supply at the two 8" meters whenever there is an emergency or construction or a repair is needed. It is recommended that, as part of the Master Plan, a comprehensive plan be developed for valve relocation or replacement such that it is possible for water service shut-off to be isolated at individual buildings or clusters of buildings. Furthermore, new water structures should be protected against the effects of soil corrosion.

Fire Water System

Currently fire water and domestic water are in a combined system on campus, with the exception of the fire prevention systems served by the newer 10" fire connection on Mills Avenue. It is recommended that a separate fire water loop be established for the campus, and that it be a dedicated fire connection on the higher pressure zone, Road 24, as is the Mills Avenue connection. This will allow domestic water to be shut-off when needed or in emergencies without compromising fire safety.

Ted Leach of the Contra Costa County Fire Prevention District confirmed that hydrant flow tests are required at the time of new construction to verify available flow capacity and pressure for new fire prevention systems and hydrants. He stated that there have been no recent flow tests requested at Contra Costa College. It is recommended that flow tests be conducted on the hydrants located at the highest elevation on campus near the Music Building in order to verify the existing pressure and flow capacity before implementing the Master Plan.

Sanitary Sewer System

The sanitary sewer system on campus is connected to the West County Wastewater District (WCWD). The pipe material is vitrified clay for all campus mains and most laterals. Some building laterals are cast iron. The main sanitary sewer line is an 8" pipe which enters the campus from the north as a 6" line serving approximately 80 homes in the residential community just north of campus. Installed in 1964, this line enters the Contra Costa College property through the Music building parking lot. This main continues south through campus, servicing the buildings on the west side of campus and then connecting to a 10" main in the parking lot north of the gymnasium. A second 8" campus main services the buildings on the east side of campus before conjoining the west main just north of the gym. This 10" line then flows west to Mission Bell Drive where it becomes a 12" main and flows south. There exists a parallel 10" line located in Mission Bell Drive which is interconnected to the 12" line. The WCWD reports that there have historically been capacity or conveyance issues with these mains located in Mission Bell Drive.

According to the WCWD the campus mains are within 10' and 12' wide easements dedicated to the WCWD. Historically, the ownership and maintenance of these lines has not been clearly defined and communicated between the campus and the WCWD.

A video survey was conducted on April 26, 2007 by V&A Consulting Engineers of the sanitary sewer lines that were identified as problematic by CCC Facilities personnel. These sewer laterals were noted for frequent blockages and required maintenance. The results of the investigation indicated that each of the lines suffered from root intrusions that occurred at pipe material transitions or at offset joints. V&A recommendations included pipe lining, point repairs, and root removal and prevention as required per location. Future improvements should be made using current WCWD specifications for pipe material and connections, which should alleviate issues of this nature.

Storm Drainage System

The existing storm drainage system on campus consists of area drains, curb inlets, trench drains and rainwater leaders connected to storm drain pipe which subsequently discharges into the natural drainage channels traversing the campus. Buildings and grounds staff report that the storm drainage system performs satisfactorily, and that there are no known areas of excessive ponding or flooding given a normal rainfall event. The open drainage channels on campus are diverted underground in four locations where required by surface improvements or roadways. In these locations, staff have reported that the upstream inflow areas for these drainage conduits require periodic maintenance, as often as three times per year, to remove debris which blocks or constricts the flow.

Storm drain improvements under the Master Plan will be influenced significantly by the recent National Pollutant Discharge Elimination System (NPDES) C3 requirements. Current regulations require that all storm water runoff be managed and treated at the source before entering the storm drainage system. There are requirements for both the quantity and the quality of runoff allowed. Adele Ho, Public Works director for the City of San Pablo, should be consulted to determine the exact requirements that will be placed on future campus development.

MASTER PLAN DESCRIPTION

4.1. Master Plan Components

Demolition:

The Master Plan targets several existing buildings for demolition. The recommendation for the demolition of each building is unique and involves a combination of several factors. These factors include the presence of structural seismic deficiencies and out-dated facilities, a strategy to re-purpose existing buildings for their best possible use, and a desire to bring a cohesive design to the campus by improving the quality of buildings and creating a sequence of integrated exterior spaces.

The buildings recommended for demolition are the following:

- Humanities
- Liberal Arts
- Maintenance
- Physical Science
- Maintenance/ Police Office
- Health Science
- Custodial Office
- Child Care Portable
- Student Life

Renovations:

The Facilities Master Plan also targets a number of buildings for renovation. The recommendation for each of these buildings to be renovated involves several factors as well. These include structural seismic deficiencies, accessibility deficiencies, a strategy to re-purpose existing buildings for their best possible use, and program restack to accommodate departmental increases and decreases.

The buildings recommended for renovation are the following:

- Gymnasium- seismic renovation
- Biological Science- seismic renovation, conversion to new Art Building

- Music- seismic renovation
- Physical Science- seismic renovation, conversion to shared College/ Community Facility
- Gym Annex- seismic renovation, accessibility upgrade including elevator
- Art- conversion to new Operations, Maintenance, Receiving, Police, Custodial, and Mail including modifications required for loading area access
- Applied Art & Administration- seismic renovation, exterior renovation to restore two-way loop road, program restack to Math, Journalism, Dental Technician, Graphics, Magazine, Radio Motion Picture and TV, ELS, Reprographics, Speech, Media Distribution
- Men's and Women's Lockers- accessibility upgrade

New Construction:

The Master Plan proposes three new buildings and a number of site renovations for the CCC Campus. These new buildings will have a similar vocabulary that borrows from the existing facilities context but also provides a fresh new look for the campus. The new site features will knit the campus together from both a pedestrian and vehicular point of view making way finding and accessibility easier for the students, faculty, and administrators.

The buildings recommended for new construction are the following:

Classroom Building 60,000gsf

The new Classroom Building location will overlap the current Humanities Building site and will provide flexible classroom space in several sizes in addition to offices and casual student interaction space. These classrooms will integrate current technology and allow for unknown future technologies in learning. As the Internet and technology have exploded, educational systems and methods have grown along with them. The media enabled classroom allows for distance and Internet instruction that are highly interactive. It also will accommodate, with its high ceilings and control of natural light, any of a wide variety of future unforeseen developments in technology.

Programs to be served by this new facility include English, Humanities, Social Sciences, English as a Second Language, African American Studies and General Classrooms.

Access to the new Art Plaza will be provided as part of the Classroom Building.

Student Life Center 36,000gsf

The new Student Life Center location will be contiguous to the current Student Services Building. The site is located slightly south and east outside the confirmed earthquake fault zone. This building will be the main focus for first-time visitors and for student life on the CCC campus. It will be one of the first buildings new students and visitors will see, and will be the most prominent building seen from the main drop-off area.

This building will hold the Student Government Offices, Café and Dining Area, Culinary Arts Program, Bookstore, and the college and Middle College High School administrations and support staff. The café, dining and bookstore areas directly adjacent to the Main Plaza will provide important gathering spaces and a setting for casual interactions and exchange of ideas.

Science and Allied Health Building 48,000gsf

The new Science and Allied Health Building location will overlap the current Liberal Arts Building site. This science-focused lab building will include wet and dry teaching lab environments for chemistry, biology, and geology as well as teaching space for geography, and astronomy. The typical lab will be flexible, allowing reconfiguration based on specific science needs and changing technologies. A New Planetarium will provide state of the art technology equaling its community college neighbors.

Allied Health programs will be relocated from its existing campus building to this new building as well. The areas requiring specialized space will be designed to meet particular programmatic requirements within a flexible building envelope. Additional clinical lab space is needed for Nursing, Medical Assisting, Certified Nurse Assistant and Emergency Medical Services. Specialized spaces will be designed to also accommodate general lab and classroom functions resulting in a high level of flexibility.

Main Plaza

A primary planning element and social gathering space will be located near the front of the new Student Life Center adjacent to the Student Services Building. This plaza will provide a highly visible “front door” for the campus and an important place for student interaction. It will be composed of both paved and planted areas with places for students to wait or gather informally.

Additional smaller plaza areas are proposed to link various campus buildings together with related design features and materials. These areas are intended to strengthen or reinforce existing campus pedestrian movement as well as creating new links and places for social interaction among students, faculty, and administration.

Amphitheater

Located near and integrated with the Student Life Center will be a large grass and concrete terraced area creating a natural amphitheater for large convocations and possibly graduation ceremonies. Acting as both a stage for activities of significance to campus life and as a place of daily student interaction, it will create a focus off the Main Plaza area.

Loop Road

The Facilities Master Plan proposes that the loop road of two-way traffic around the campus be realized in its initial phase and revised to incorporate additional City-owned property as possible in future phases. Currently a portion (transformer enclosure) of the Applied Arts and Administration Building impinges upon the ability to provide a two-way loop road around the campus. The Master Plan suggests relocating the existing transformers at the Applied Arts and Administration building in addition to regrading at the steeply sloped roadway in the same location to allow two-way traffic around the CCC Campus. See Two-Way Loop Roadway (Section 4.5) for additional information.

MASTER PLAN DESCRIPTION

4.1. Master Plan Components

Campus Entry Points

The Facilities Master Plan proposes demarcation of the three major vehicular entry points into the CCC Campus with an architectural signage element. This element would be designed to signify entry from the surrounding community onto the campus and may be composed of brick elements in order to tie contextually with the existing campus.

Vehicular Drop-offs

The Facilities Master Plan proposes two major drop-off points for the campus designating safe and clear area for this specific purpose. These drop-off areas would coincide with two of the three major vehicular entry points and would begin the sequence of outdoor plaza spaces at each of their respective locations. The two locations proposed include the southern entry off Mills Avenue and the northern entry off Campus Drive.

Secondary Site Improvements

The Facilities Master Plan includes several site improvements to generally improve the ease of use and the character of the campus. These include:

Art/Music Buildings Bridge Link - between the new Art Building location and existing Music Building a new bridge crossing the existing stream will provide a physical connection between these two departments which now share some facilities.

Perimeter Fence Replacement- a perimeter fence replacement will provide the opportunity for increased security and an improvement to the character of the campus that directly interfaces with the community.

Secondary Plaza Area -an Art Plaza is proposed in place of the old Physical Sciences Building that is to be demolished. This space is envisioned as an area that can be used by the art program for changing exhibits that feature the work of the department.

Secondary Plaza Area -a Science Plaza is proposed between the new Classroom Building and the new Science and Allied Health Building. This space is envisioned as an area that can feature the science and allied health programs with elements such as a sundial, a medicinal garden, or other science related exhibits.

Campus Site Infrastructure Upgrade

The Facilities Master Plan includes upgrades to the water and sewer systems through out the site. Details of the current conditions and areas of recommend work can be found in the Site Utilities Diagrams (Section 4.9.)

MASTER PLAN DESCRIPTION

4.1 Master Plan Components

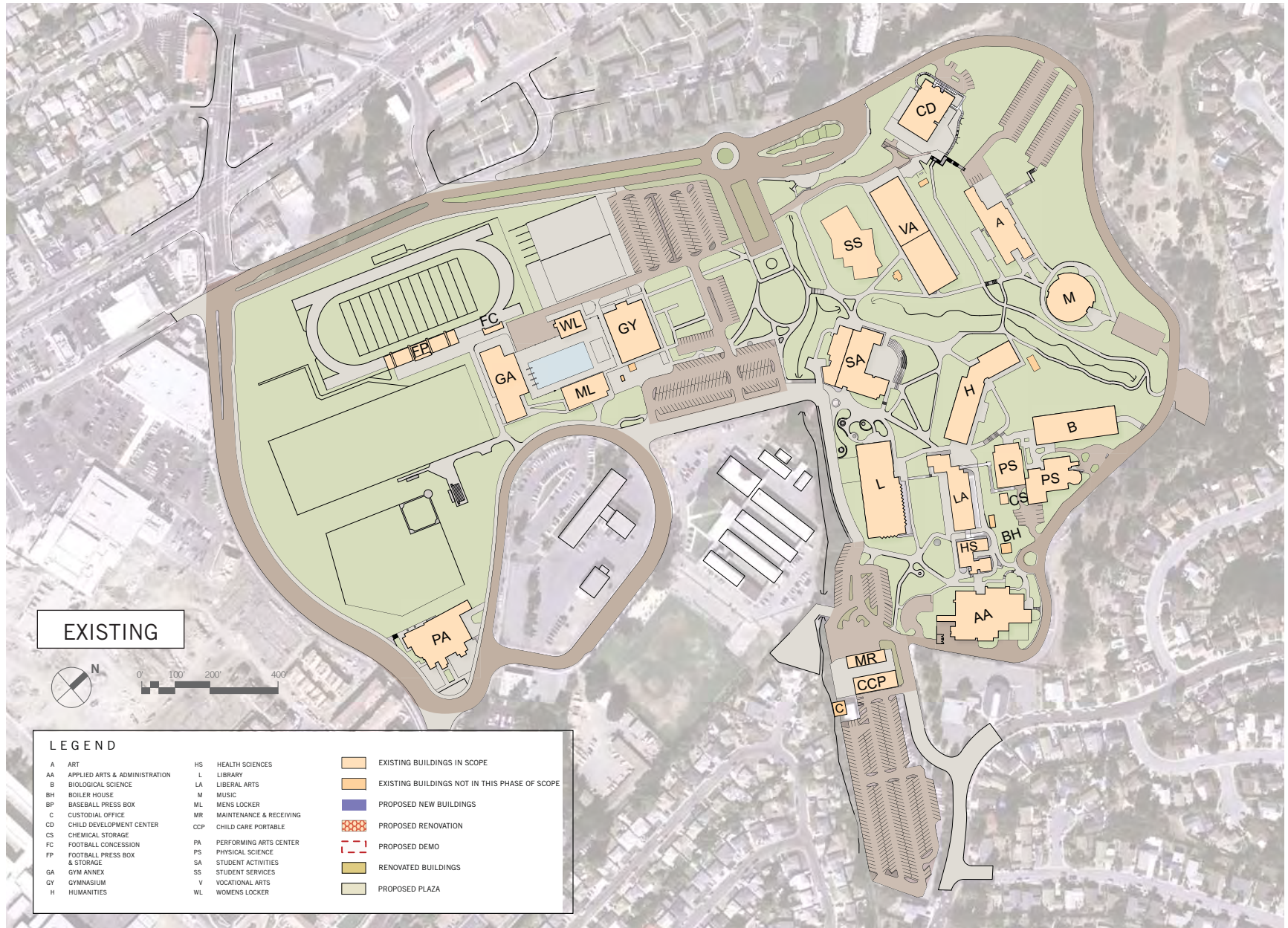

MASTER PLAN DESCRIPTION

4.2. Master Plan Phasing

As part of a detailed programming exercise following the Master Planning effort all programs should be evaluated and like programs which are currently dispersed in several buildings should be combined as departments in their own locations.

Current projects on-going on the CCC Campus will be completed prior to the commencement of the Master Plan phasing below. This includes but is not limited to the completion of the Library Building renovation, the Field Replacement, the new Student Services Building and the relocation of the Student Services spaces from the Humanities Building to the new Student Services Building. In addition the Math program classrooms and offices currently residing in the Humanities Building will be relocated to the Applied Arts and Administration Building.

Building and site design will integrate varying site elevations that influence accessibility as part of each phase.

The extent of campus site landscape and infrastructure upgrades will be addressed as appropriate to each phase, but is generally described below. A 5-phase diagram for landscape and Infrastructure upgrades is included at the end of this section. More information on each Master Plan Component of work can be found in Section 4.1 Master Plan Components.

Prior to commencement of each construction phase the contractor will provide a construction access plan describing their routes of material delivery and lay down space. These plans shall maintain accessible routes of travel throughout the campus during construction.

The Master Plan proposes the following sequencing of construction activities:

Phase 1 - year 2008-2010

Relocate:	Math Department will be relocated to the AA Building
Demolish:	Humanities Building Perimeter Fence
Construct:	Vehicular Drop-off (north) Classroom Building Perimeter Fence Campus Entry Points (north and west)
Renovate:	Gym Annex AA Building to accommodate the Math Department (non-seismic work)
Site Utilities:	Remove or abandon sanitary sewer, storm drain, and water service to Humanities Building. Install new sanitary sewer, storm drain, and water service to new Classroom Building. Install new firewater loop for main campus connected to higher pressure zone. Replace inoperable water valves.

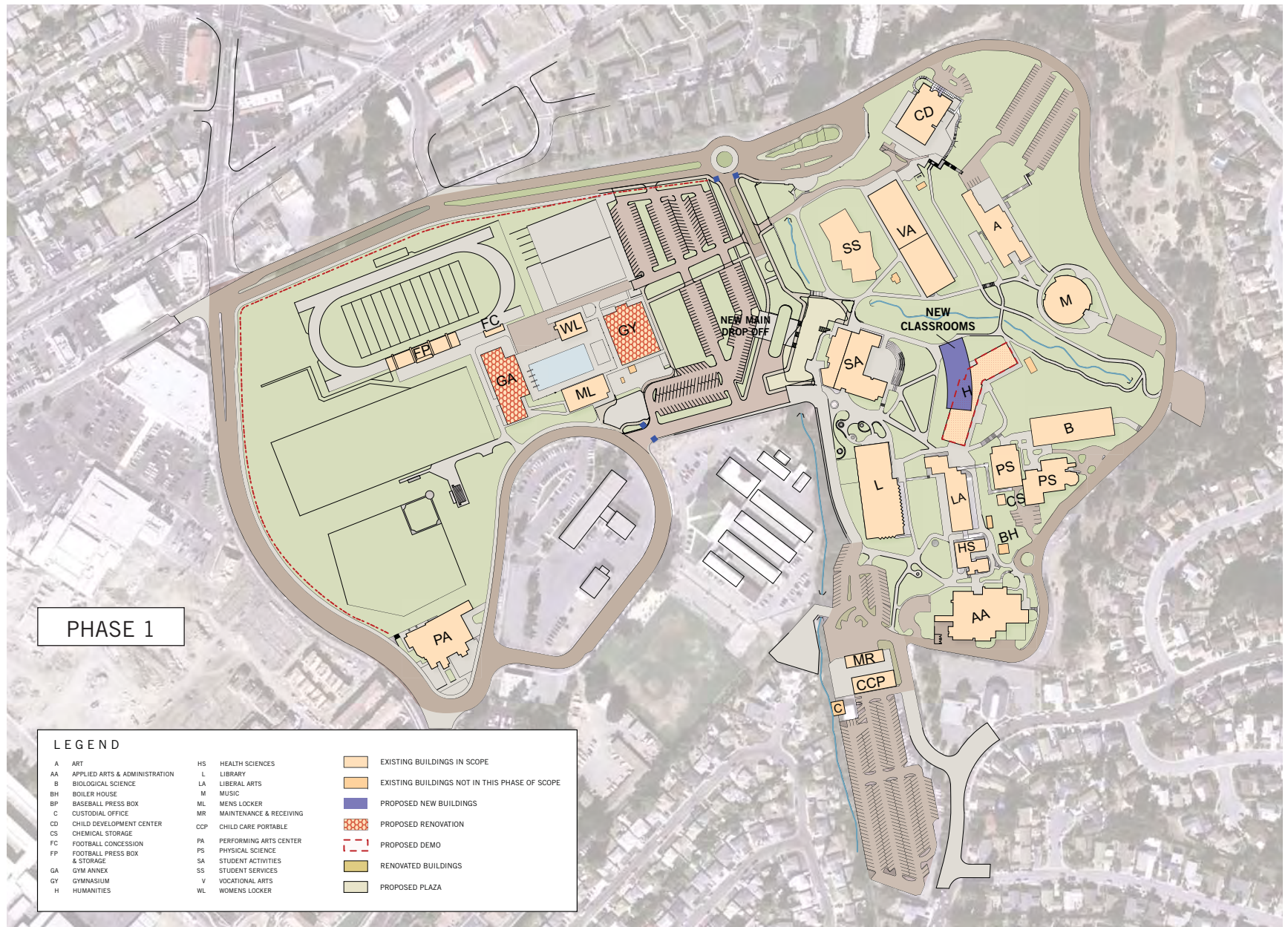

MASTER PLAN DESCRIPTION

4.2. Master Plan Phasing

Phase 2A - year 2009-2012

Relocate:	Liberal Arts Building programs to new Classroom Building including Drama, Assessment, Academic Skills, ESL, Foreign Language, Speech, Cooperative Education, Early Childhood Development, Health and Human Services, Medical Assisting, African American Studies, Business and Real Estate, CTC, and Social Sciences
Demolish:	Liberal Arts Building
Construct:	Sciences and Allied Health Building Amphitheater Secondary Plaza Area- Science Plaza
Renovate:	The Gym AA Building to accommodate the Speech Department
Site Utilities:	Remove or abandon sanitary sewer, storm drain, and water service to Liberal Arts Building. Install new sanitary sewer, storm drain, and water service to new Science Building.

Phase 2B - year 2011-2014

Relocate:	Student Life Center programs to the new Classroom Applied Arts & Administration Buildings Student Life Center spaces including the Bookstore, Reprographics, Associated Student Offices to the Applied Arts & Administration Building- some temporary and some permanent relocations Student Life Center Cafeteria temporarily out of service and replaced with vehicular vendor trailers behind library, utilities to be provided if required Student Life Center Fireside Room temporarily out of service Student Life Center Recreation Room temporarily out of service Student Life Center Health Services relocated temporarily to the Applied Arts & Administration Building
Demolish:	Student Life Center
Construct:	Student Life Center Main Entry Plaza
Renovate:	Men's and Women's Locker Rooms
Site Utilities:	Install new sanitary sewer, storm drain, and water service to new Student Life Center..

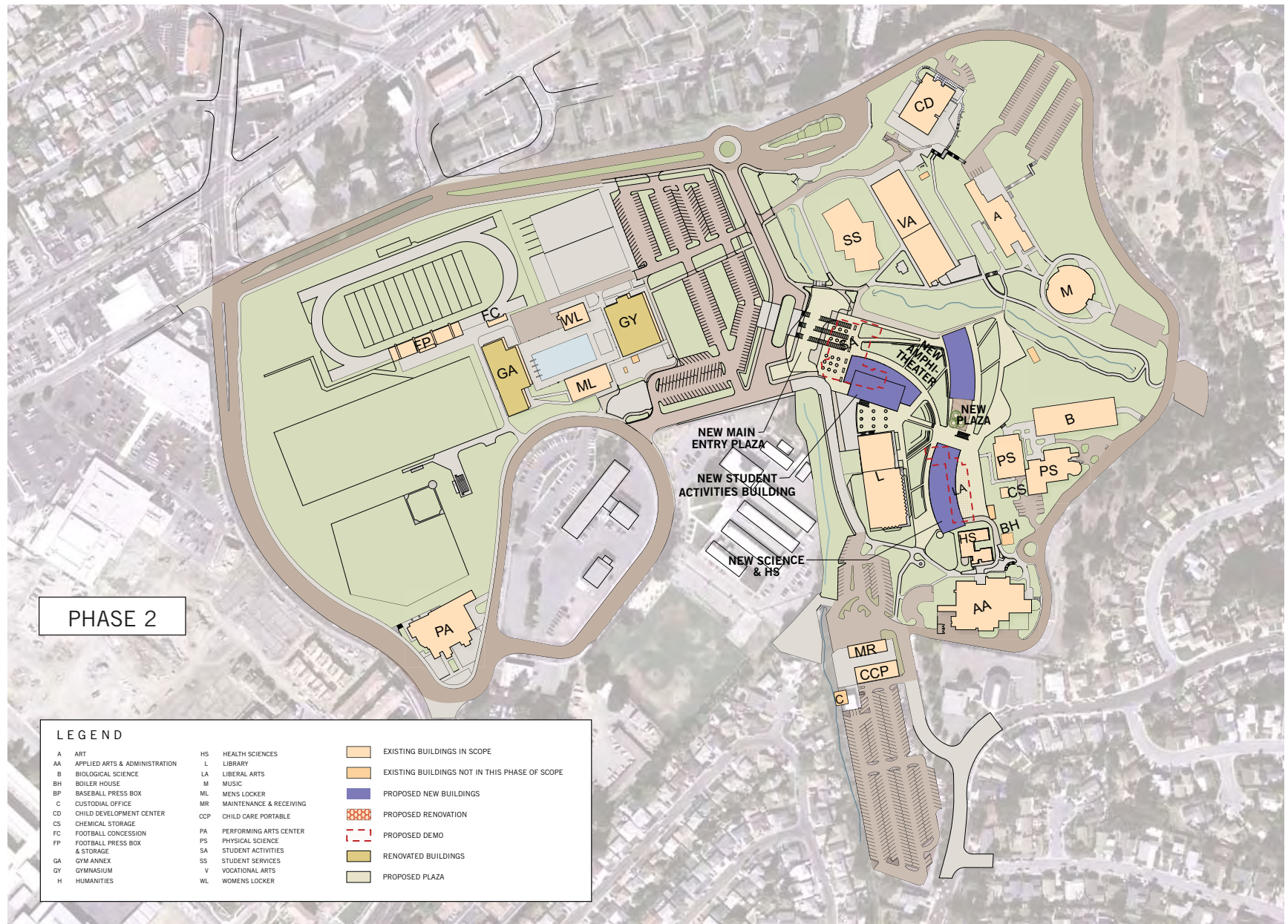

MASTER PLAN DESCRIPTION

4.2. Master Plan Phasing

Phase 3- year 2014

Relocate:	<p>Biology Building program to new Sciences and Allied Health Building</p> <p>Physical Science programs including Geography, Geology, Astronomy, Chemistry, and Physics to new Sciences and Allied Health Building</p> <p>Planetarium to new Sciences and Allied Health Building</p> <p>Health Sciences to new Sciences and Allied Health Building</p>
Demolish:	<p>Health Sciences Building</p> <p>Physical Science Building (older portion only)</p>
Construct:	<p>Secondary Plaza Area- Art Plaza</p> <p>Operations and Maintenance Loading Area</p> <p>Bridge Link between new Art and existing Music Buildings</p>
Renovate:	<p>Biology Building to accommodate the new Art program adding kiln zone at exterior</p> <p>Existing Art Building loading dock to new Operations & Maintenance loading area</p> <p>Physical Science Building (newer portion only) to shared College/ Community Facility</p> <p>Applied Arts and Administration Building summer renovation with programs remaining in building</p> <p>Music Building summer renovation with program remaining in building</p>
Site Utilities:	<p>Remove or abandon sanitary sewer, storm drain, and water service to Health Sciences Building and older portion of Physical Sciences Building.</p>

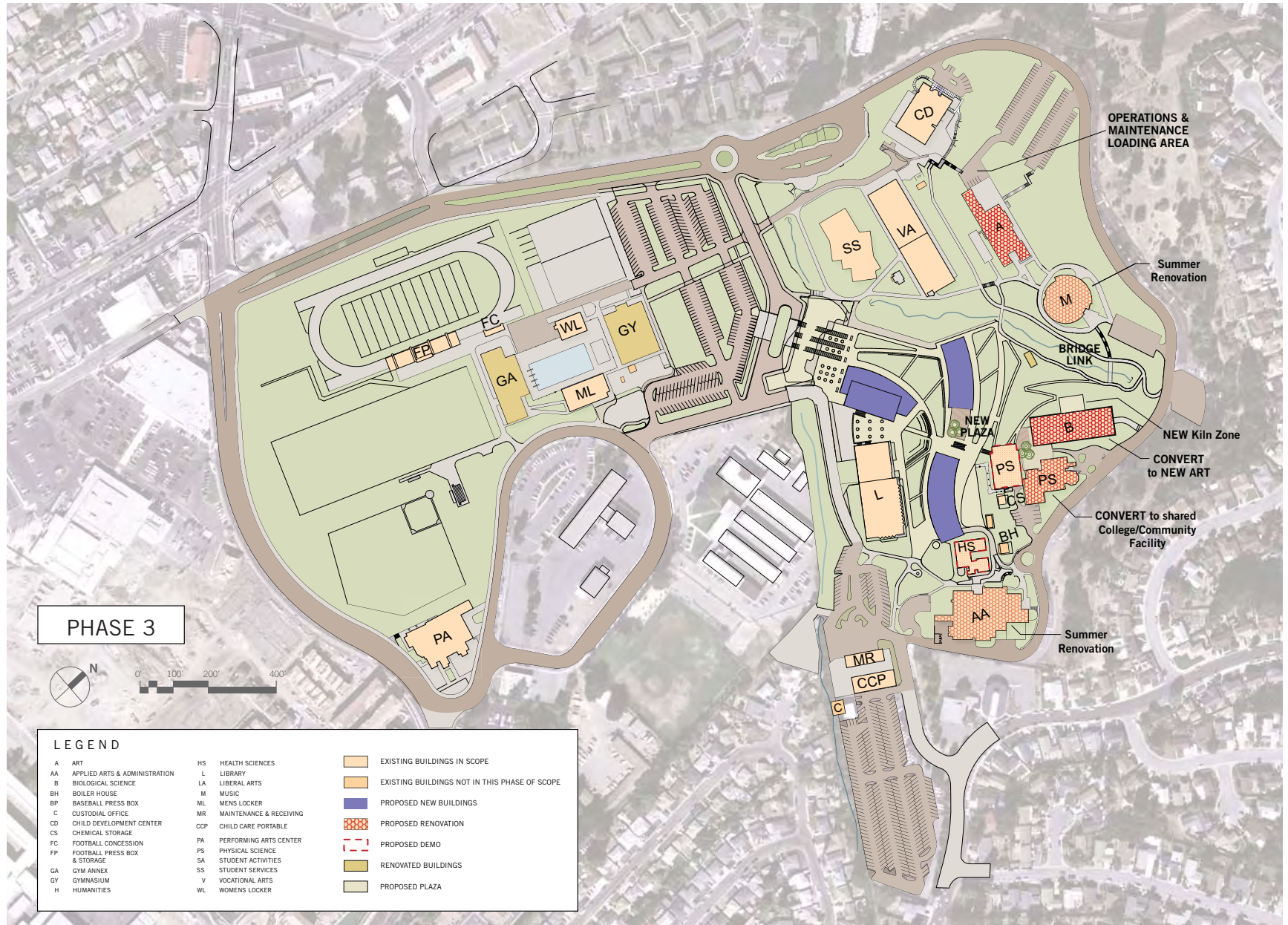

PHASE 3

LEGEND

A	ART	HS	HEALTH SCIENCES		EXISTING BUILDINGS IN SCOPE
AA	APPLIED ARTS & ADMINISTRATION	L	LIBRARY		EXISTING BUILDINGS NOT IN THIS PHASE OF SCOPE
B	BIOLOGICAL SCIENCE	LA	LIBERAL ARTS		PROPOSED NEW BUILDINGS
BH	BOILER HOUSE	M	MUSIC		PROPOSED RENOVATION
BP	BASEBALL PRESS BOX	ML	MENS LOCKER		RENOVATED BUILDINGS
C	CUSTODIAL OFFICE	MR	MAINTENANCE & RECEIVING		PROPOSED PLAZA
CD	CHILD DEVELOPMENT CENTER	CCP	CHILD CARE PORTABLE		
CS	CHEMICAL STORAGE				
FC	FOOTBALL CONCESSION				
FP	FOOTBALL PRESS BOX & STORAGE				
GA	GYM ANNEX				
GY	GYMNASIUM				
H	HUMANITIES				
		WL	WOMENS LOCKER		

MASTER PLAN DESCRIPTION

4.2. Master Plan Phasing

Phase 4 - year 2015

Relocate:	Art Program to renovated Biology Building Operations, Maintenance Receiving, Police, Custodial, and Mail to renovated Art Building Electrical transformer to widen roadway at Applied Arts & Administration Building
Demolish:	Operations and Maintenance Building Custodial Building Child Care Portable
Construct	Vehicular Drop-off (south) Campus Entry Point (south) Transformer enclosure near Applied Arts & Administration Building
Renovate:	No buildings are renovated for this phase
Site Utilities:	Remove or abandon sanitary sewer, storm drain, and water service to old Operations and Maintenance Building.

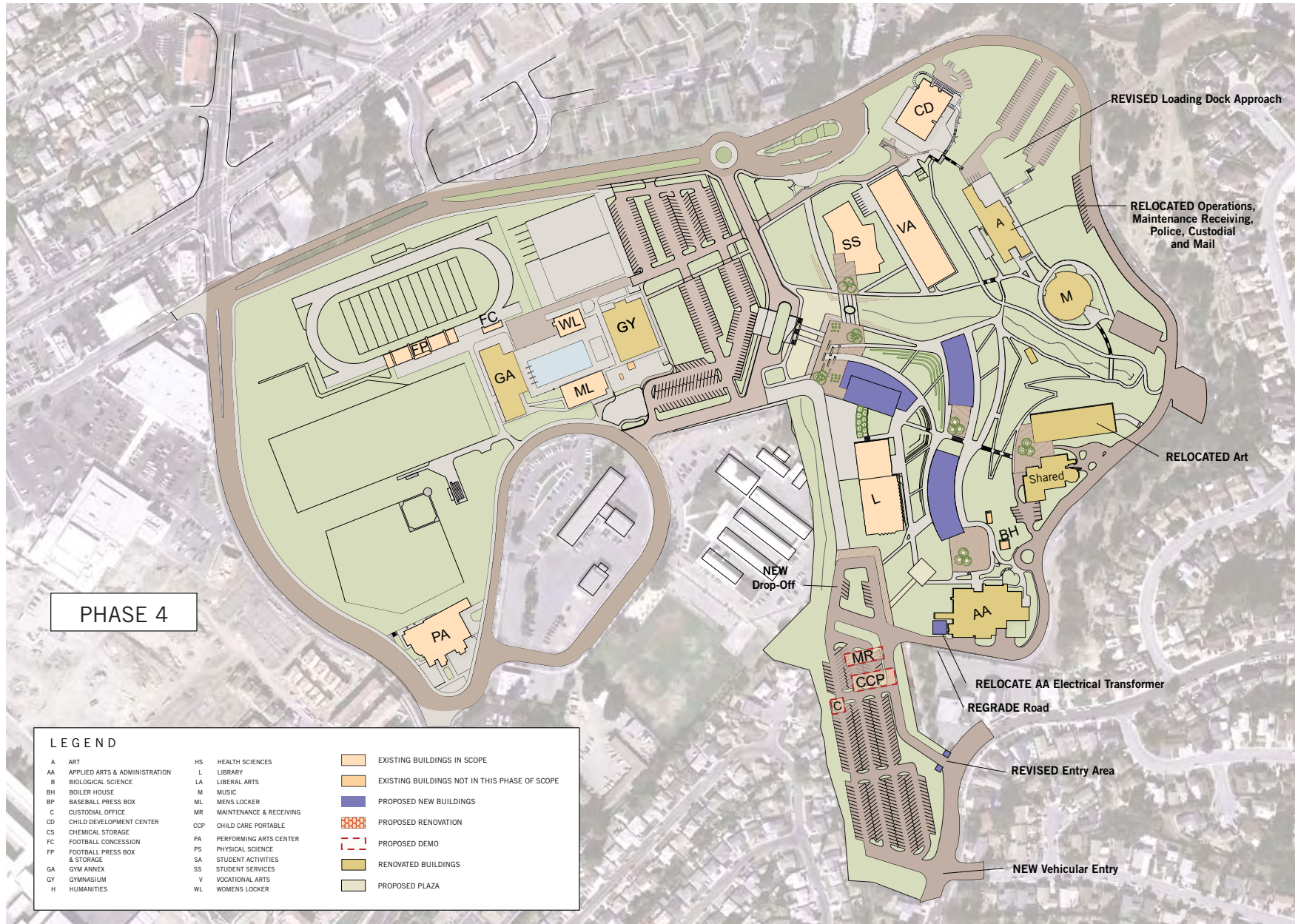

MASTER PLAN DESCRIPTION

4.2. Master Plan Phasing

Phase 5 - year 2016

Phase 5 would involve the acquisition by CCC of the National Guard Armory building and construction of a loop road to the campus. An investigation of the existing Armory building should be undertaken to determine if the building is suitable for use by CCC without a seismic upgrade. A condition assessment should also occur during the due diligence phase of acquisition. Several use options exist for the Armory building depending on the condition of the building, including:

- **Buildings & Grounds and Receiving:** This operating unit would be relocated to the Armory site instead of the Art Building. The Art building would be demolished. The Armory has excellent street access for deliveries and the vehicles used by this unit.
- **Auto Body & Maintenance Shop:** Automotive Services is located next to the Computer Technology Center. Improving public access to this program would increase the opportunity for students to work on cars from public customers. Locating the auto program at the Armory site also would allow the Vocational Arts building to be used by other programs and would remove the storage and cars associated with the program from the core of the campus.
- **Dormitory for foreign students:** A goal of the college is to increase foreign student enrollment by 5% per year. Should the Armory building meet structural requirements of the state, an option could be to use it for housing foreign students. The college would lease the facility to a private vendor who would operate it.
- **Property exchange with City of San Pablo:** The City of San Pablo currently owns the El Portal School site that is adjacent to the core of the campus. The City has proposed an exchange of the college property that borders El Portal Drive for the school site. The developer who would acquire this property would also work with the college to relocate athletic facilities and fields to the school site and the Armory site. The school site is located adjacent to the Armory and is in the AP zone, so no new structures can be constructed in this area. Instead, the existing school structures could be demolished so athletic fields and parking can be built in these areas.

Phase 5 also would incorporate a reconfigured campus loop road around the perimeter of these parcels. This would greatly improve the campus traffic flow and reduce the convergence of vehicles and pedestrians on the current perimeter road.

Site Utilities: Install new storm drain for new fields, parking and loop road. The utilities associated with the acquisition of the Armory and San Pablo School sites would need to be evaluated during the due diligence phase as the Master Plan only addresses the infrastructure currently associated with the college.

If these sites are acquired prior to Phase 4 being complete then the scope of each phase outlined above should be re-evaluated based on this development.

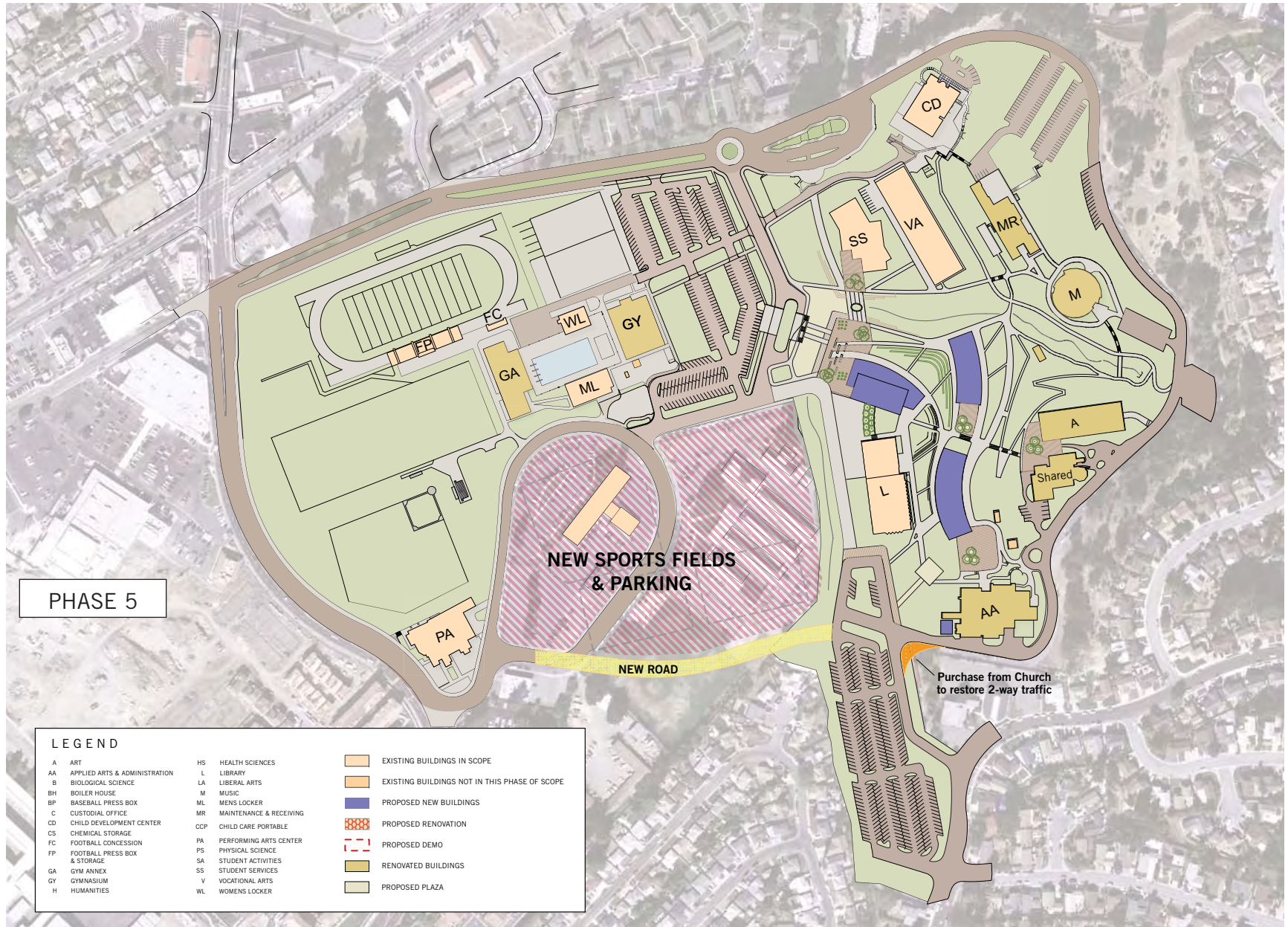

MASTER PLAN DESCRIPTION

SITE AREAS PHASING SUMMARY

- (P1) PHASE 1
- (P2A) PHASE 2
- (P2B) PHASE 2
- (P3) PHASE 3
- (P4) PHASE 4
- (P5) PHASE 5

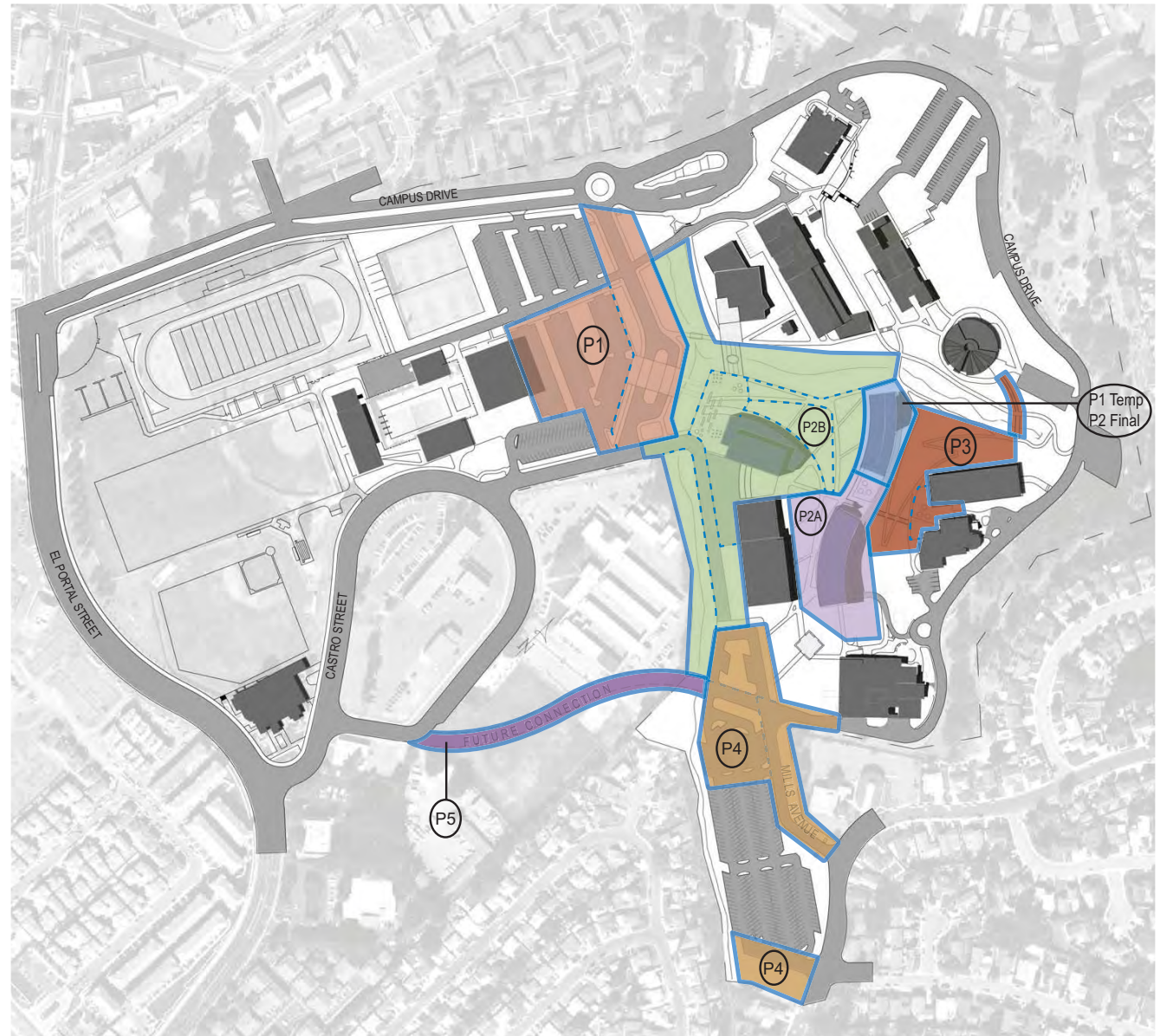

MASTER PLAN DESCRIPTION

4.3. Educational Master Plan Integration

Education Master Plan Description

The Contra Costa College (CCC) Master Plan is an outgrowth of the Educational Master Plan. Instructional, student services and administrative facilities needs were identified during the educational planning process and cited in that document. Reliance on those processes and procedures provides the basis for facilities planning:

Project Scope and Conditions

Bond funds must be used for educational purposes

The desire of the college is to utilize the bond funds for improvements and renovations in educational programs as well as new construction projects. Additional State funding is being requested for seismic rehabilitation programs.

Other uses for the bond funds that can be considered must be educational in nature or must directly support the college's educational mission. (Note that compatible uses may be vocational or functional support type in nature.)

Project Programs

The programs at the college use approximately 234,094 assignable square feet (ASF). An area breakdown by building is provided in Section 4.4. The following programs are represented at the campus, although some may be temporarily displaced:

Academic

- Academic Skills
- Administration of Justice
- African American Studies
- Anthropology
- Art
- Automotive Services (including Refrigeration and Appliance Repair)
- Biological Sciences (including Biotechnology)

- Business (including Real Estate)
- Chemistry
- Computer and Communications Technology
- Computer Information Systems including (Business Office Technology)
- Computer Science (including High Performance Computing and Robotics)
- Cooperative Education
- Cosmetology
- Counseling
- Culinary Arts
- Dental Assisting
- Drama
- Early Childhood Education (including Education)
- Early Learning Center
- Earth Sciences
- Economics
- Engineering (including Architecture, Drafting)
- English
- English as a Second Language
- Foreign Languages
- Geography
- Geology
- Graphic Communication
- Health and Human Services (including Medical Assisting & Emergency Medical Sciences)
- History
- Humanities (including Philosophy)
- Journalism

- La Raza Studies
- Library Studies
- Mathematics
- Media and Communication Arts
- Music
- Nursing
- Physical Education (including Health Education)
- Physical Education – Intercollegiate Athletics
- Physics (including Astronomy)
- Political Science
- Psychology
- Social Sciences (including Economics, History, Political Sciences, Psychology and Sociology)
- Speech

Administrative & Student Support Services

- Admissions and Records
- Assessment
- Bookstore
- CalWorks
- DSPS
- Financial Aid
- Transfer and Career Center
- Matriculation
- Communication, Liberal Arts, Skills and Services Division
- Library, Allied Health, Vocational Training and Athletics Division
- Natural, Social and Applied Sciences
- Business Office

- Buildings and Grounds
- Dean of Students
- Dean of Instruction
- Dean of Economic Development
- Dean of Planning, Research and Student Outcomes
- Office of the President
- Office of the Vice President of Academic and Student Affairs
- Police Services
- Technology Services
- Student Activities

Highlight of the facilities requirements identified in Educational Master Plan

The Science and Allied Health programs at the college are experiencing increased student demand and have strong growth potential. Also, these programs are currently located in old facilities and need more modern teaching space to enhance the teaching and learning. In California, most science buildings built more 30- to 40-years ago are in need of replacement due to non-complying code conditions, seismic considerations, deterioration due to use of hazardous materials and modern teaching methods.

The science programs at CCC are no different and are located in facilities that are outdated, seismically deficient, undersized and do not allow for tutoring. A new Science and Allied Health complex would solve this problem.

The Art Building currently needs extensive seismic retrofitting. The program could be relocated into another facility (to the Biology Building), thus removing the Art Building from the instructional inventory. If this work were phased properly, it would require minimal program disruption.

The LA Building is antiquated and in need of seismic retrofitting. This building is the most used lecture classroom building on the campus and is currently the location for a large portion of the scheduled classes. The age of the facility, its current condition, the configuration of the classrooms and the cost of rectifying these problems make it unfeasible to remodel. A new facility is needed.

MASTER PLAN DESCRIPTION

4.3. Educational Master Plan Integration

Culinary Arts is a growing program and is in need of additional square footage. Also, the program is currently located in the AA Building, which places it far away from the center of campus. This location is not conducive to students accessing the restaurant during its hours of operation since it is not near the food service center of the campus. Relocating this program into the expanded Student Life Center will eliminate these issues.

Many of the college's administrative offices are located in the AA Building. This location is difficult to access for visitors, students and staff. The need to place these offices in the center of campus near student services and student activities has been identified.

The Physical Education and athletic complex is challenged by the need for seismic retrofitting and expansion of facilities to accommodate increased student demand. The current Fitness Center is serving over 800 students each term, yet it needs extensive updating to accommodate the potential demand of more students. Also, the Gym Annex is without an elevator, thus making the second floor inaccessible to students with many physical disabilities.

In general, the ADA access on the campus is not very good. The topography of the site requires students to walk the gentle rolling terrain to go from one class to another. Many paths of travel and the building entrances need to be updated to accommodate disabled students.

Additional resource needs identified in Educational Master Plan

The Educational Master Plan also identified consistently a need to upgrade both hardware and software for numerous programs on the campus. This was a recurring theme for many of the programs listed in the Educational Plan.

MASTER PLAN DESCRIPTION

4.4. Space Summary

Existing Bldg #	Building Name	Construction Year	Total Room ASF	Total OGSF	Space Percent Efficient	Master Plan Proposal	Currently in Chancellor's Office Instructional Space Inventory	Master Plan Proposal Chancellor's Office Instructional Space Inventory	Total Demo OGSF	Total Renovate OGSF	Renovation Purpose/Change to Program
7	FOOTBALL PRESS BOX	1982	480	490	98.0%	No Change	0	0			
8	FOOTBALL CONCESSION BLDG	1982	350	375	93.3%	No Change	0	0			
9	BASEBALL PRESS BOX	1982	86	91	94.5%	No Change	0	0			
10	GYMNASIUM	1957	17,659	18,092	97.6%	Renovate	X	X		18,092	structural/seismic
11	HUMANITIES	1954	14,684	21,036	69.8%	Demolish	X	X	21,036		
12	PE STORAGE	1995	1,868	2,232	83.7%	No Change	0	0			
14	LIBERAL ARTS	1967	18,820	33,000	57.0%	Demolish	X	X	33,000		
15	LIBRARY	1963	0	32,904	0.0%	No Change	X	X			
16	BIOLOGICAL SCIENCE	1961	14,820	19,505	76.0%	Renovate	X	X		19,505	structural/seismic; convert to new Art Building
17	MAINTENANCE	1959	5,423	5,636	96.2%	Demolish	0	0	5,636		
19	MEN'S LOCKER	1957	6,699	8,560	78.3%	Renovate	0	0		8,560	accessibility uppgade
20	MUSIC	1964	8,242	14,522	56.8%	Renovate	X	X		14,522	structural/seismic
21	PHYSICAL SCIENCE	1957	15,120	21,430	70.6%	Partial Demolish Partial Renovate	X	0	10,000 Confirm	11,430 Confirm	newer portion to remain is adjacent to roadway; structural/seismic; convert to shared College/ Community Facility
23	STUDENT ACTIVITIES	1957	19,466	23,018	84.6%	Demolish	X	X	23,018		
28	VOCATIONAL ARTS	1957	15,373	30,912	49.7%	No Change	X	X			
29	WOMEN'S LOCKER	1962	2,859	4,479	63.8%	Renovate	0	0		4,479	accessibility upgrade
33	MAINT/POLICE OFFICES	1967	3,035	6,570	46.2%	Demolish	0	0	6,570		
35	P.E. MULTI-PURPOSE (GYM ANNEX)	1969	16,472	24,972	66.0%	Renovate	X	X		24,972	structural/ seismic; accessibility upgrade
37	ART	1971	0	15,900	0.0%	Renovate	X	0		15,900	convert to new Operations, Maintenance, Receiving, Police, Custodial, and Mail Building
38	HEALTH SCIENCES	1973	7,442	10,132	73.5%	Demolish	X	X	10,132		
39	PERFORMING ARTS CTR	1980	15,596	21,000	74.3%	No Change	0	0			
40	APPLIED ARTS & ADMIN.	1982	34,345	50,000	68.7%	Renovate	X	X		50,000	structural/seismic, exterior renovation to restore two-way loop road, program restack to Math, Journalism, Dental Technician, Graphics, Magazine, Radio Motion Picture and TV, ELS
41	CUSTODIAL OFFICES	1998	827	1,392	59.4%	Demolish	0	0	1,392		
42	CHILD DEVELOP. CTR	2003	10,697	14,504	73.8%	No Change	X	X			
43	CHEMICAL STORAGE BLDG.	1997	3,731	4,560	81.8%	No Change	0	0			
44	STUDENT SERVICES BUILDING	2008	0	0	0.0%	No Change	X	X			
TOTALS:			234,094	385,312			0	0	100,784	156,030	
New Building	Building Name	Phase	Total Room ASF	Total OGSF	Space Percent Efficient Required	Master Plan Proposal					Program
A	CLASSROOM	Phase 1	42,500	60,000	70.8%	New	0	X			General Classrooms, Humanities, Liberal Arts
B	SCIENCES AND ALLIED HEALTH	Phase 2	35,500	48,000	73.9%	New	0	X			Health Science, Biology, Chemistry, Geography, Geology, Astronomy, Physics, Planetarium
C	STUDENT ACTIVITIES	Phase 2	24,500	36,000	68.0%	New	0	X			Student Government Offices, Café and Dining Area, Culinary Arts Program, Administration, Bookstore, and the Middle College Program.
TOTALS:			102,500	144,000			0	0			

MASTER PLAN DESCRIPTION

4.5. Vehicular, Emergency and Fire Truck Access

Vehicular Circulation Description

The campus is currently accessed at three points of entry: The main entry in the north from Mission Bell Drive and El Portal, a second entry in the west from Castro Street and a southern entry on Mills Avenue from Shane Drive. Existing entry points lack hierarchy and clarity. In addition, circulation through and around campus is difficult and confusing due to multiple one-way parking lots that serve as part of the primary circulation, several intersections that create conflicts between vehicles and pedestrians, and topographic challenges that make access to many buildings difficult. The Master Plan will maintain and improve each of these vehicular access points. Vehicular circulation to the east and upper side of campus will be maintained with minor improvements. The Master Plan incorporates the following improvements to clarify and improve the entry experience, vehicular circulation, parking access, fire and service access.

- Improve the main entry drive to create a sense of arrival and clearly identify it as the primary campus entry.
- Provide a new main entry drop-off area opposite the Student Services and Student Administration buildings.
- Clarify circulation and provide a new drop-off area at the southern Mills Avenue entry.
- Establish a two-way loop around the east edge of campus to improve circulation and fire truck access to upper campus.
- Improve fire truck and emergency access to all existing and proposed buildings.
- Provide new service and loading areas.

Main Entry

The main entry from Mission Bell Drive will be reconfigured to create a single two-way entry drive from the round-about to a new drop-off area. Eliminating the parking lot at the entry and providing an improved entry drive with new landscape features will create a sense of arrival at the main drop-off area. The main drop-off area is oriented to a new series of campus entry plazas at the Student Services and Administration Buildings and is located adjacent to Rheem Creek.

South Entry

Several improvements are recommended at the south entry to improve circulation, create a sense of arrival, eliminate vehicular and pedestrian conflicts and provide an improved drop-off area. Mills Avenue is shifted west to clarify the difficult circulation at the end of the drive, create a direct flow of traffic to the new drop-off area south of the Library, and allow for a wider turning radius to the east loop road. This shift will also ease the grading constraints that limit two-way traffic on the loop road.

Two-Way Loop Roadway









Currently, the campus loop road has one-way access traveling north from Mills Avenue to the Music Building parking lot, where it becomes a two-way road for the remainder. To improve campus access and traffic flow, it is desirable to improve the loop road to two-way access for its entirety. Two-way access is not possible in the existing condition due to the constriction of the loop road at the southeast corner of the Applied Arts & Administration building. In this location, the roadway width narrows to 21' between the AA Building and the adjacent property line, and the existing roadway segment has a very steep grade of 19%.

Possible options for further study:

- Remove or relocate the existing equipment yard and retaining wall at the southeast corner of Building AA, allowing room for two 14' lanes of travel. This option could allow a less steep grade, but would change the layout of the parking area south of Building AA and would alter the intersection at Mills and the loop road, possibly affecting the ADA parking and drop-off area.
- Purchase an 8' wide section of the neighboring church property, allowing for two 14' lanes of travel. This option would preserve the parking and drop-off area, but may require prohibitively steep grades approaching the intersection from the north.
- Purchase property in the north side parking lot of the church, creating a new two-way entry to the campus from Shane Drive. The City may not be willing to approve a second campus entrance so close to the Mills entrance, and does not provide for a continuous loop road entirely on campus property.

4.5. Vehicular, Emergency and Fire Truck Access

VEHICULAR ACCESS & CIRCULATION

-  MAJOR 2 - WAY
-  PARKING 2 - WAY
-  ONE WAY
-  SERVICE ACCESS
-  DROP OFF
-  1 SERVICE ONLY
-  2 WIDEN AS NECESSARY FOR 2 - WAY LOOP
-  3 REGRADE AND RECONFIGURE ROAD TO ALLOW 2-WAY LOOP
-  4 SHIFT MILLS AVENUE WEST TO ALLOW LARGER TURNING RADIUS TO LOOP ROAD
-  5 PROVIDE NEW ACCESS TO PARKING AREA

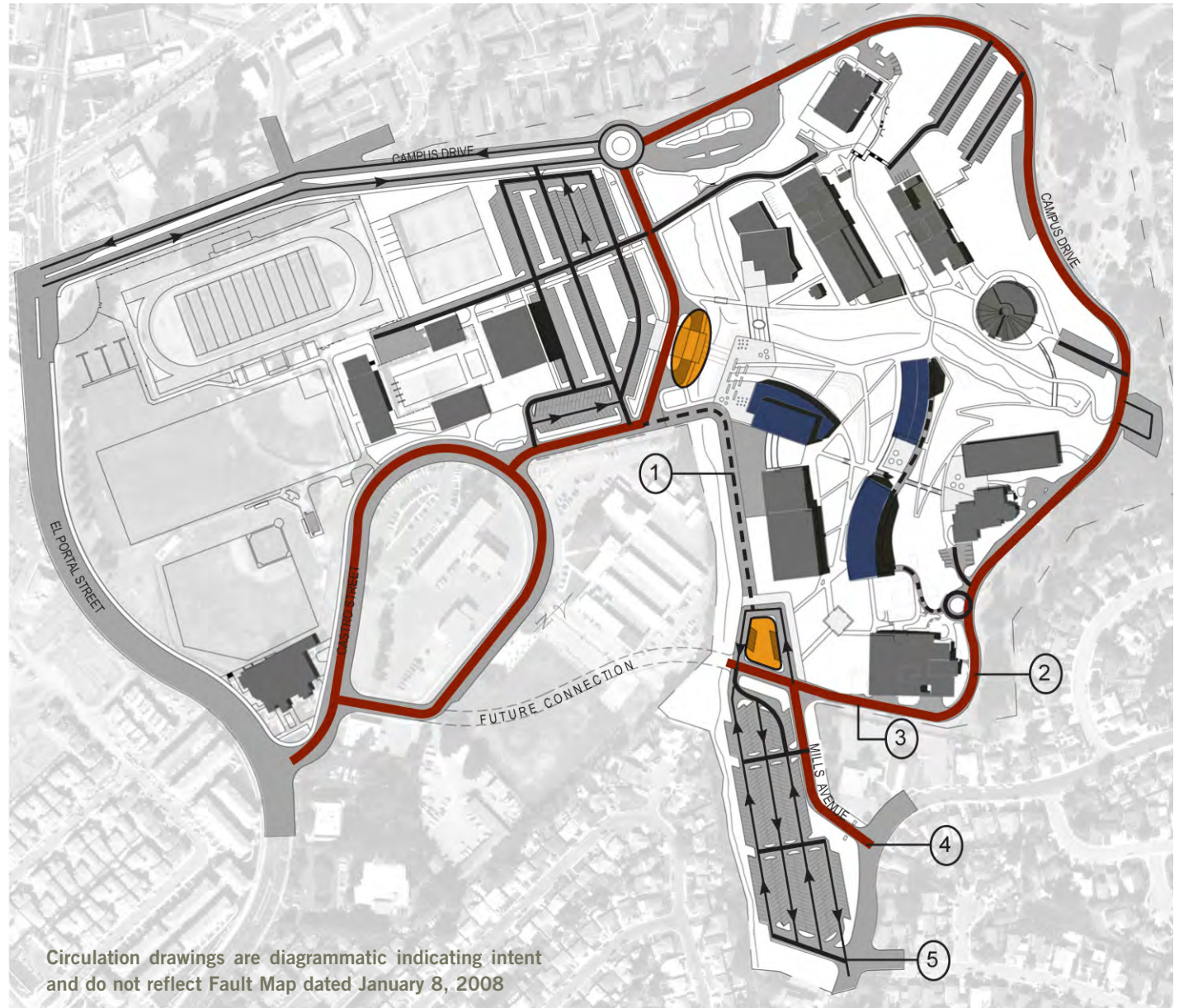

Circulation drawings are diagrammatic indicating intent and do not reflect Fault Map dated January 8, 2008

MASTER PLAN DESCRIPTION

4.5. Vehicular, Emergency and Fire Truck Access

Future Loop Road Connection

A future loop road connecting the south entry area and east loop road to Moraga Avenue and El Portal should be considered as part of long-term planning. This connection is associated with the option of reconfiguring campus recreation fields and providing new public recreation fields on the existing high school site adjacent to Rheem Creek and is contingent on a property exchange between the College District and the Public School District. It will also require coordination with the City of Richmond and the City of San Pablo.

Emergency and Fire Access

Emergency and Fire Truck access will be improved by the general modifications to vehicular circulation on campus. The two-way loop road will provide a direct route for access to the upper campus from the south. New emergency and service routes designed as pedestrian paths will provide access on the east and west sides of the new Classroom and Science and Allied Health Building. These routes will also provide access to the amphitheater and campus quad. A detailed analysis of fire truck access should be completed and coordinated with the local fire marshal as part of each phase of building construction.

Service Access

The proposed Student Life Center is served by a large loading area with space for 5 axle WB-40 trucks positioned between the south edge of the building and the Library. The loading area will be accessed by a service only route between the Library and Rheem stream and will serve as the primary loading area for large deliveries to campus. The service area should be screened and separated from the area above by a series of planted areas to deter pedestrian circulation. The service route along the stream is envisioned as a promenade located beside the creek. The primary emphasis of the design should be on the pedestrian experience. Improvements should be integrated with creek restoration efforts.

Additional pedestrian/service routes will be developed to the west of the Student Services building and the new Classroom and Science and Allied Health building as noted above. Service areas and access points to existing and renovated buildings will be maintained.

Truck Access Ramp to Proposed Receiving







Plans to convert the existing Arts Building to Receiving will require truck access to the proposed loading dock at the west end of the building. Currently, there is a 150' asphalt paved ramp, 20' wide with a 10% grade descending from the parking lot to the west end of the Arts Building. The layout of this ramp, the paved receiving area adjacent to the building, and the orientation of the proposed dock area are such that the following truck movements are allowed:

- An SU-30 truck (single-unit with a 20' cargo area) can drive forward down the ramp, pull forward to the paving limits at the bottom and reverse into a loading dock. This truck can then pull forward up the ramp to exit.
- A WB-40 truck (semi-truck with 33' trailer) requires maneuvering to back down the ramp and into a specific loading dock area. Although this is possible, the required maneuvering by the operator on a narrow steep slope makes this option not advisable. Furthermore, the 28' wide driveway entrance to the parking lot requires that this truck would need to back into the parking lot first before backing down the ramp. Backing into the driveway entrance would utilize both lanes of the loop road and would be a tight fit for the truck.

The access ramp pavement appears to be distressed and the pavement condition should be evaluated to verify that it can sustain the required truck loading.

4.5. Vehicular, Emergency and Fire Truck Access

EMERGENCY & SERVICE ACCESS

-  EMERGENCY / FIRE ACCESS
-  EMERGENCY / SERVICE ONLY PEDESTRIAN ROUTE
-  ACCESS POINT
-  MAIN SERVICE & LOADING AREA
-  EMERGENCY & SERVICE ACCESS ONLY
-  POTENTIAL FIRE ACCESS TO CENTRAL CAMPUS
-  RECONFIGURE TO ALLOW ACCESS TO NEW BUILDING
-  O & M LOADING AREA

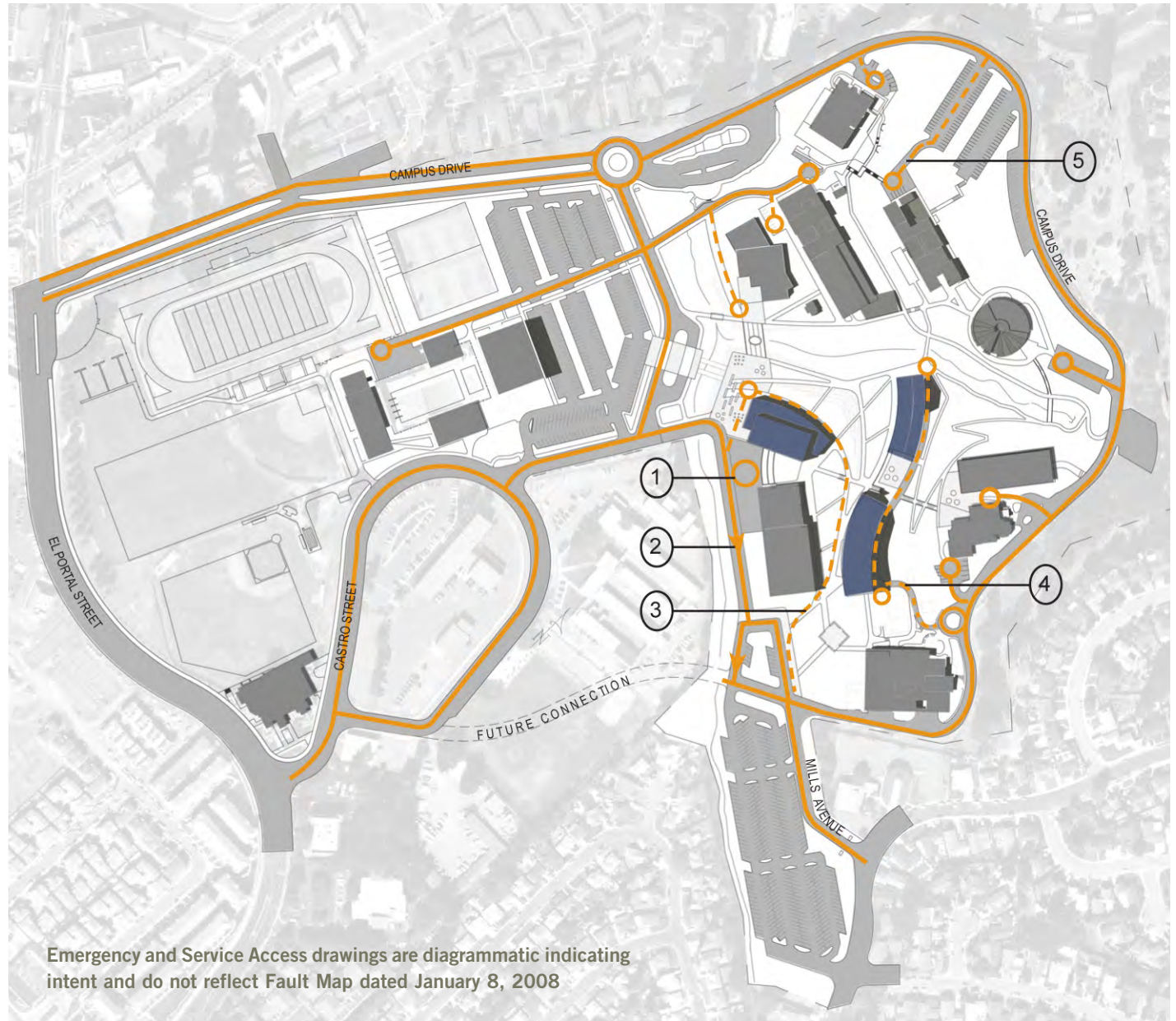

Emergency and Service Access drawings are diagrammatic indicating intent and do not reflect Fault Map dated January 8, 2008

MASTER PLAN DESCRIPTION

4.6. *Parking and Pedestrian Circulation*

Parking

Existing parking areas and the total number of parking spaces are essentially maintained with significant modifications to the main parking area (lot A) at the north entry and south parking area (lot C). The proposed modifications accommodate new drop-off areas and improve circulation and connectivity. The total number of parking areas are essentially maintained with anticipated net loss of 5 parking spaces as indicated in the table. A net increase of parking is provided in both the main and south parking areas closest to the main campus buildings. Universally accessible parking spaces are integrated with the drop-off areas directly adjacent to the campus. Improving signage for all parking lots is essential to improving the flow of traffic through the campus.

PARKING AREAS

AREA	(E) QTY	(P) QTY	NET
LOT A	338	366	+28
LOT B	47	12	-35
LOT C	297	311	+14
LOT D	12	0	-12
LOT E	9	9	0
LOT F	10	10	0
LOT G	40	40	0
LOT H	32	32	0
LOT I	24	24	0
LOT J	47	47	0
LOT K	54	54	0
LOT L	6	6	0
LOT M	2	2	0
LOT N	17	17	0
STREET PARKING	147	147	0
TOTAL	1082	1077	-5

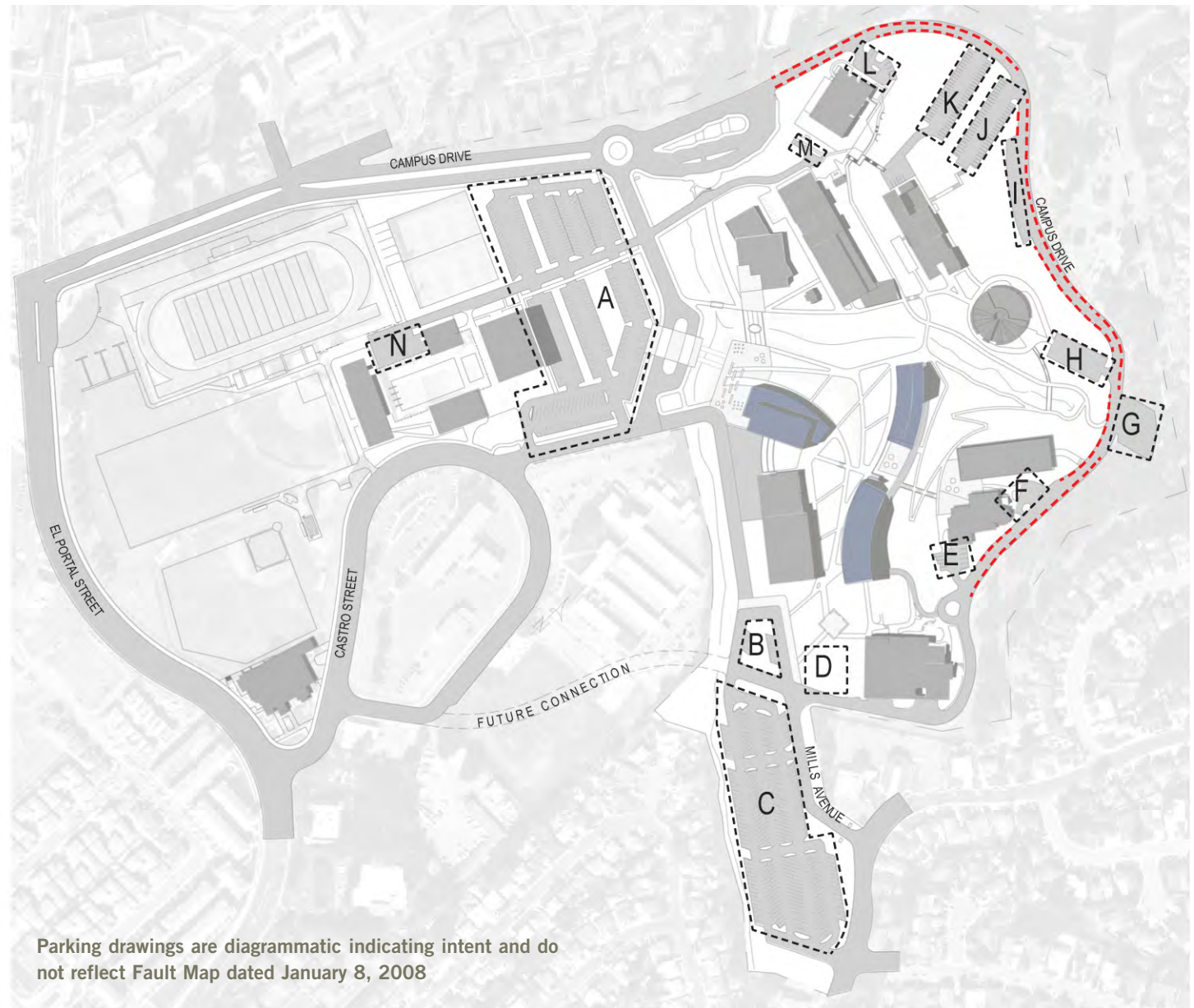

MASTER PLAN DESCRIPTION

4.6. Parking and Pedestrian Circulation

Pedestrian Circulation

Existing pedestrian circulation is challenged by a lack of hierarchy and significant topographic changes that currently limit universal access. The Master Plan organizes the pedestrian circulation into primary and secondary routes with the intent of providing universal access to and between all existing and proposed buildings. The College has undertaken a universal access compliance study and this work should be coordinated with the Master Plan to ensure that universal access is maintained and improved with each phase of construction.

Entry and Arrival

Pedestrian circulation from parking areas is strengthened and focused on the main campus entry points. Rheem Creek creates a barrier between the main parking area and campus, however it can and should be embraced and improved as a gateway that enhances the sense of arrival and passage into campus. A prefabricated pedestrian bridge is proposed to link the main drop-off area to the entry plaza across the stream.

Student Plaza and Campus Center

The Master Plan incorporates the College's goal of re-centering the campus with a new entry and student event plaza and adjacent quad. The new plaza is linked to the Student Services plaza (currently under construction) and integrates the stream to create an inviting new amenity that provides a connection to water and natural processes at the heart of the campus. Circulation in the core of the campus is reconfigured to provide universal access to the proposed buildings.

Upper Campus Connections

Universal access to the central campus plaza between the proposed Classroom and Science and Allied Health Buildings will be provided via elevators inside the buildings. The Master Plan proposes removal of the existing bridge and steel canopy from the Liberal Arts building to the physical sciences building and replacement with a ramp and stair system to provide access to a new Arts plaza.

Upper Stream Crossing and Art Walk

A second bridge should be studied for cost benefit to connect the Music building to the new Art building (currently Biology). This connection is completed with the addition of a new ramp and stair system linking the upper campus and could be developed as an art walk with interactive art work created by students.

This connection is combined with the lower plaza and improved circulation to the existing bridge to strengthen connections between the north and south portions of the campus.

PEDESTRIAN CIRCULATION

- PRIMARY CIRCULATION ROUTE
(IMPROVE OR PROVIDE ADA/TITLE 24
COMPLIANT ROUTE OF TRAVEL)
- SECONDARY CONNECTIONS
- ① NEW PATH
- ② POTENTIAL BRIDGE CONNECTING NEW
ARTS BUILDING WITH MUSIC BUILDING
- ③ NEW PATH/ADA RAMP
- ④ REMOVE EXISTING BRIDGE AND STAIR/
CANOPY REPLACE WITH NEW STAIR AND
RAMP SYSTEM
- ⑤ IMPROVE PEDESTRIAN CIRCULATION
ALONG PERIMETER. ADD SIDEWALK
WHERE POSSIBLE
- ⑥ NEW STREAM PATH
- ⑦ PREFABRICATED PEDESTRIAN BRIDGE

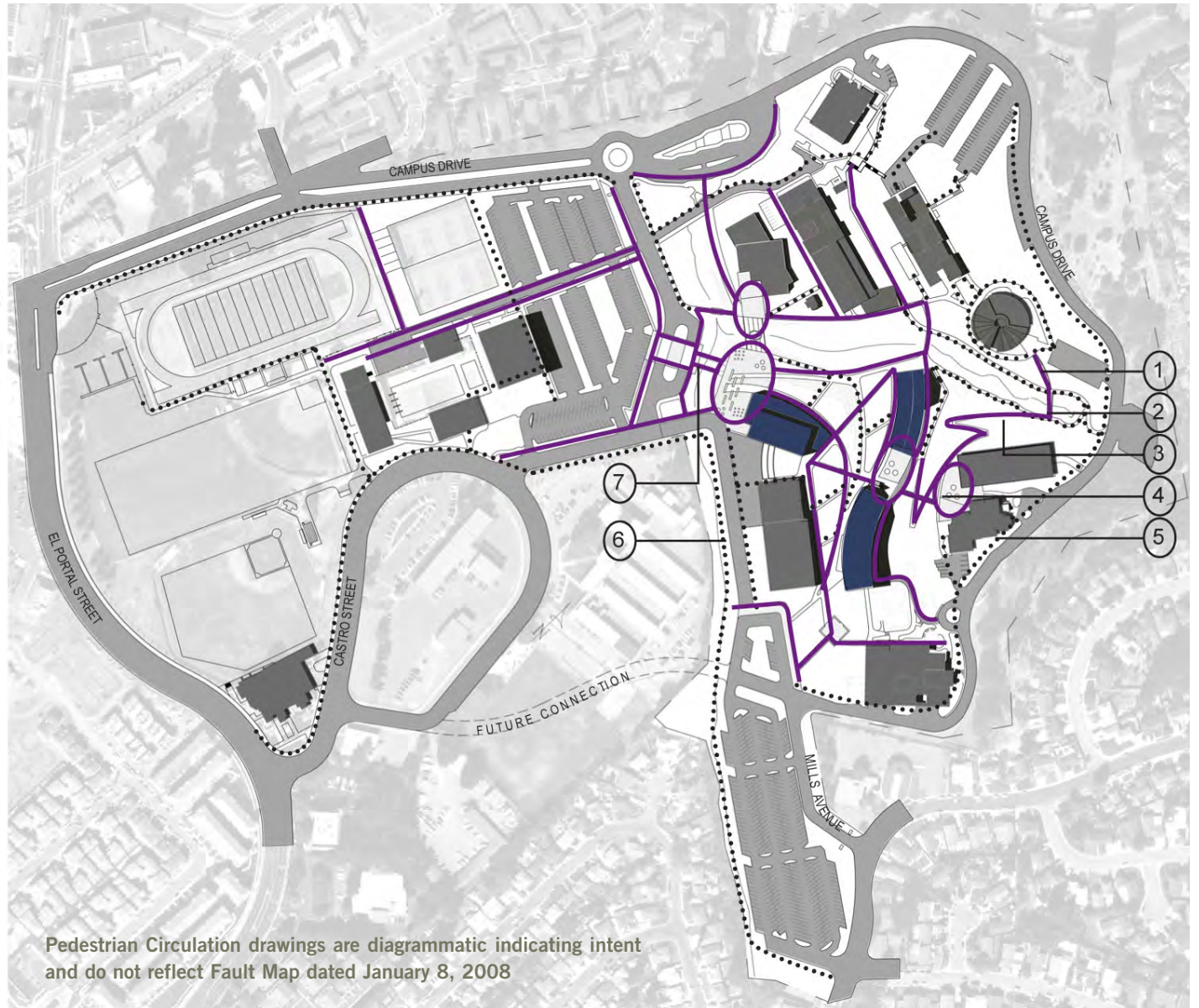

Pedestrian Circulation drawings are diagrammatic indicating intent and do not reflect Fault Map dated January 8, 2008

MASTER PLAN DESCRIPTION

4.7. Site Landscape Areas and Types

Existing landscape conditions and proposed Master Plan improvements suggest a series of distinct landscape areas and types characterized by use, experience, and maintenance requirements. A summary of each follows.

Area A: Active Recreation

The existing recreational and sports area is maintained with no proposed modifications with exception to ongoing maintenance and facilities upgrades as determined by the facilities department. This area may be reconfigured if options for use of the adjacent El Portal School and Armory sites are pursued.

Area B: Parking

Refer to parking section for detailed overview. Low maintenance regime.

Area C: Entry and Drop-off Areas

As described in the vehicular access and pedestrian circulation sections. These areas are designated as medium to high maintenance.

Area D: Bus Stop and Drop-off Area

The Master Plan maintains this area as is, with incremental access and landscape improvements as needed.

Area E: Riparian Stream Corridors

As noted in the Landscape and Site Conditions Section the stream corridors present both constraints and opportunities. The unique position of the streams in a largely urbanized area with limited habitat and natural areas and close proximity to the Bay present an excellent opportunity. On the other hand the streams divide the campus and create safety issues related to visibility and lighting.

By embracing the streams and building on the original arboretum project the campus can integrate the streams into the environmental science curriculum

with a series of restoration projects to create a distinct campus landscape which provides habitat and storm water treatment functions. Safety and lighting issues should be addressed by removal of older non-native trees and undergrowth and the addition of lighting. This area should be developed for a low maintenance, natural management regime. The College is currently collaborating with the Urban Creeks Council on a grant to restore the creeks that flow through the campus. Restoration of these creeks will support educational initiatives by various departments.

Area F: Campus Center – Lower Hillside

This area is defined by a transition from the steeper slope to a more gradual area and includes the primary campus open spaces. The landscape is defined by a combination of higher use lawn areas, ornamental planting, and low maintenance meadow areas to achieve a medium maintenance regime in general.

Area G: Hill Terrace – Oak Woodland

This area is defined by steep slopes and building terraces with limited maintenance. Numerous stands of excellent trees provide an informal and naturalistic environment. These attributes can be enhanced with incremental restoration and maintenance projects to create an Oak Woodland – grassland environment with a low maintenance regime. Fire hazards should be evaluated and addressed in future development and maintenance of this area.

Area H: Upper Hillside – East Perimeter

This area is defined by steep slopes and serves as a buffer between adjacent residential areas making use and building difficult. Refer to Area G for landscape type and treatment.

Area J: West Perimeter

Refer to next section.

4.7. Site Landscape Areas and Types

LANDSCAPE AREAS & TYPES

- (A) ACTIVE RECREATION AREA
- (B) PARKING
- (C) ENTRY & DROP OFF AREAS
- (D) BUS STOP
- (E) STREAM CORRIDOR / ARBORETUM
- (F) CAMPUS CENTER LANDSCAPE
- (G) HILL TERRACE LANDSCAPE
- (H) EAST PERIMETER LANDSCAPE
- (J) WEST PERIMETER LANDSCAPE



Landscape Area drawings are diagrammatic indicating intent and do not reflect Fault Map dated January 8, 2008

MASTER PLAN DESCRIPTION

4.7. Site Landscape Areas and Types

Entry and Perimeter Landscapes

The Master Plan includes a series of new entry monuments, and landscape and signage improvements to increase visibility and signify entry. Entry monuments and signage should be developed as a cohesive vocabulary of elements with a clear hierarchy that provides clear direction to the main entry gateway. A secondary gateway will be created at the south entry. The gateways should be reinforced with improved landscape corridors flanking the entry drives. Existing markers on El Portal should be repositioned and replaced to provide a cohesive image and increase visibility.

The campus currently lacks visibility on its most public and western edge. This edge is defined by a 12 foot chain link fence and a beautiful but dense evergreen tree planting which blocks the campus from view. The Master Plan proposes that the fence be moved to the area behind the tree planting and adjacent to the sports fields to reduce the visibility of the fence. In addition, openings in the evergreen planting should be created to provide views into and out of the campus. The chain link fence should be removed and replaced with an enhanced fence and signage to connect the campus with the broader community.

In the long-term, the stand of large eucalyptus trees behind the bleachers on Mission Bell Drive should be removed and replaced with trees and groundcover that improve the image and the views from the entry road.

ENTRY MONUMENTS & PERIMETER LANDSCAPE

- ① REPLACE MONUMENT WITH NEW STANDARD
- ② CREATE OPENINGS IN PERIMETER LANDSCAPE TREES TO ALLOW MORE VISIBILITY INTO AND OUT OF CAMPUS. PROVIDE NEW SIGNS ON FENCING IN THESE LOCATIONS.
- ③ RELOCATE FENCE BEHIND PERIMETER LANDSCAPE TO REDUCE VISIBILITY OF FENCE
- ④ NEW ENTRY LANDSCAPE GROUNDCOVER
- ⑤ REMOVE EUCALYPTUS
- ⑥ MAIN ENTRY MONUMENT/SIGN
- ⑦ SECONDARY MONUMENT/SIGN
- ⑧ EAST PERIMETER FENCE (CURRENTLY PLANNED)
- ⑨ ENTRY LANDSCAPE IMPROVEMENTS

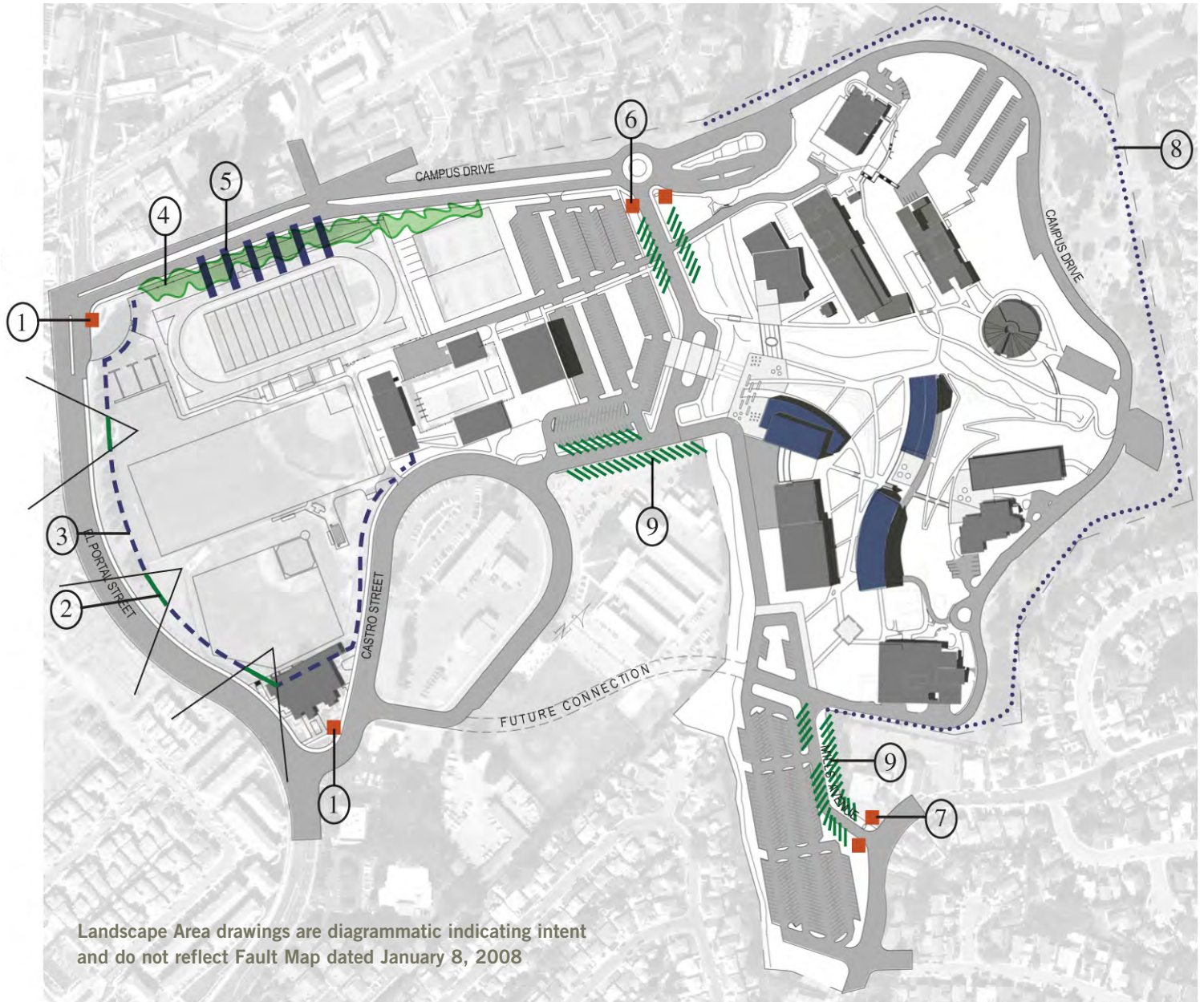

Landscape Area drawings are diagrammatic indicating intent and do not reflect Fault Map dated January 8, 2008

MASTER PLAN DESCRIPTION

4.8. Site and Recreational Program Areas

Plazas

A series of new plazas are proposed at key pedestrian nodes between buildings throughout the campus to provide active and programmed areas for a wide variety of student events and gatherings as well as daily use. The primary student event plaza will create a new center for the campus that builds on the concentration of students and circulation between the Student Services Building and the proposed Student Life Center. A second plaza will be located on a terrace between the proposed Classroom and the Science and Allied Health Buildings. A third plaza is proposed for the upper area between the new Arts and multipurpose building. This plaza is uniquely positioned to take advantage of Bay views to the west and will also serve as an Arts terrace for exhibits and ongoing projects. These plazas should reiterate the style and ambience of the plaza between the AA Building and the Library.

Campus Quad and Amphitheater

An informal amphitheater for College events and gatherings is proposed as the central feature in a new campus quad. The amphitheater will be combination of paved and lawn terraces to create an inviting environment that is comfortable for every day use as well as special events.

Stream Corridor and Oak Woodland

As noted the landscape areas and types, both the stream corridor and the upper hillside, offer excellent 'natural' environments for contemplative seating areas and passive uses. They also offer a unique context for environmental education in conjunction with the environmental sciences program and restoration efforts. Student participation in restoration and landscape improvements would provide educational opportunities as well as team building skills and a connection with the natural environment. In addition to general environmental literacy the curriculum could include riparian ecology, stream morphology, biology, chemistry, and water quality. The college should consider expanding grant opportunities with the Urban Creeks Council.

Recreational and Miscellaneous Uses

All existing recreational, sports and other uses are maintained with no proposed modifications.

PROGRAM AREAS

- ① NEW ENTRIES & DROP OFFS
- ② NEW CENTER OF CAMPUS ENTRY & STUDENT ACTIVITIES PLAZAS
- ③ NEW CAMPUS QUAD & AMPHITHEATRE
- ④ NEW MID TERRACE PLAZA
- ⑤ NEW UPPER ARTS PLAZA
- ⑥ EXISTING PLAZA
- ⑦ EXISTING DROP OFFS
- ⑧ TENNIS
- ⑨ TRACK & FIELD
- ⑩ GENERAL SPORTS FIELDS
- ⑪ ENVIRONMENTAL EDUCATION STREAM CORRIDOR
- ⑫ ARTS WALK



Landscape Area drawings are diagrammatic indicating intent and do not reflect Fault Map dated January 8, 2008

MASTER PLAN DESCRIPTION

4.8. Site and Recreational Program Areas

Entry and Student Event Plazas and Pedestrian Corridors

Each plaza should incorporate and address the following elements and design considerations.

- A variety of gathering areas and seating types for individuals, small and large groups.
- Information Kiosks and Campus Maps
- Shaded and Sunny areas through out the day
- Wind protection (where applicable)
- Unique features and elements
- Pedestrian Scale
- Flexibility



ENTRY AND STUDENT PLAZA

- ① NEW DROP OFF
- ② REMOVE EXISTING OUTFALL STRUCTURE
- ③ INTEGRATE STREAM AND STORMWATER TREATMENT INTO PLAZA
- ④ CAFE SEATING AREAS
- ⑤ LARGE TABLES AND SEATING AREAS
- ⑥ STREAM TERRACES
- ⑦ PEDESTRIAN BRIDGE
- ⑧ INFORMAL AMPHITHEATER
- ⑨ SERVICE AREA
- ⑩ SCREENED TERRACES



MASTER PLAN DESCRIPTION

4.8. Site and Recreational Program Areas

Amphitheater Precedents

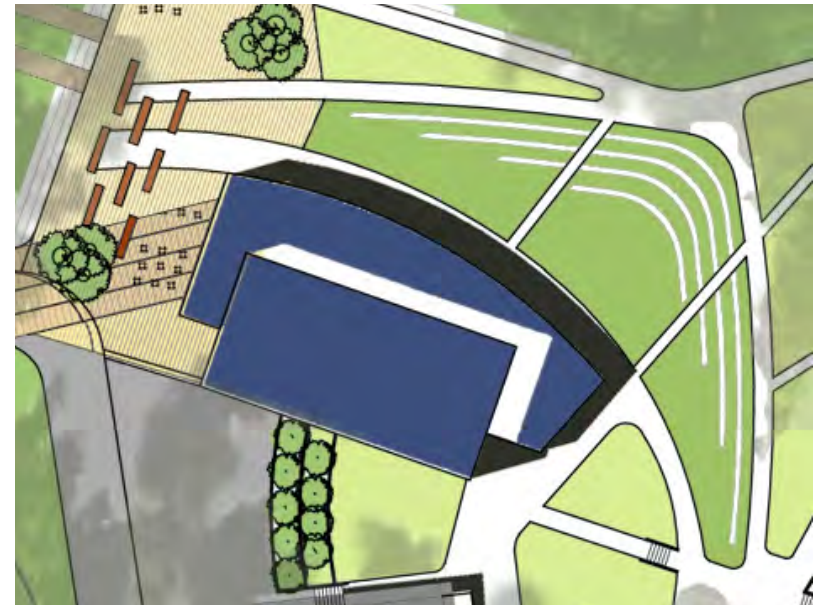

SANITARY SEWER SYSTEM

- EXISTING WCWD (PUBLIC) SS MAIN
- EXISTING CCC SANITARY SEWER LINE
- PROPOSED SANITARY SEWER PHASE 1
- PROPOSED SANITARY SEWER PHASE 2A
- /// REMOVE OF ABANDON

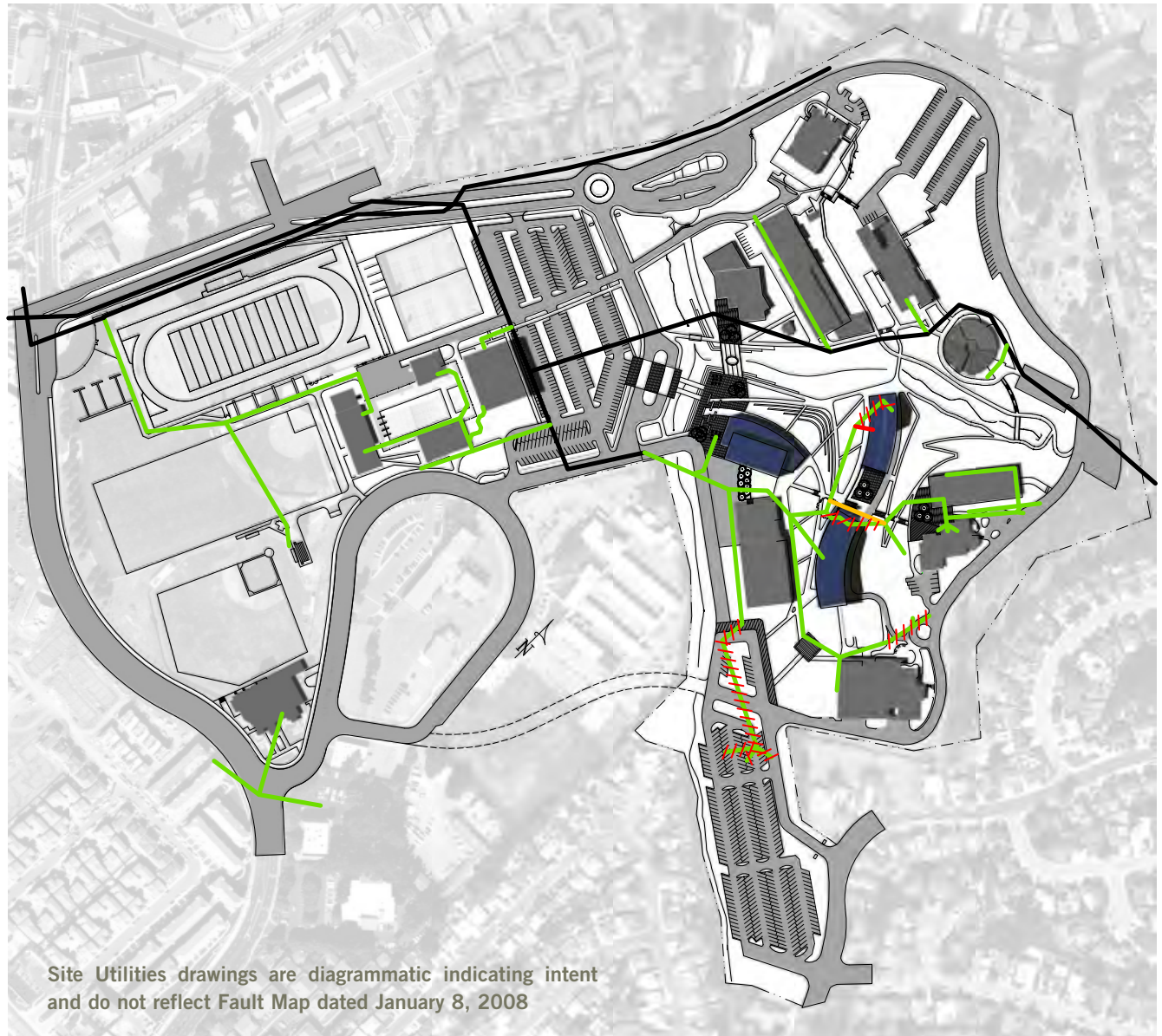







Site Utilities drawings are diagrammatic indicating intent and do not reflect Fault Map dated January 8, 2008

MASTER PLAN DESCRIPTION

4.9. Site Utilities Diagrams

STORM DRAIN SYSTEM

-  EXISTING STORM DRAIN LINE
-  EXISTING OPEN DRAINAGE CHANNEL
-  PROPOSED STORM DRAIN IMPROVEMENTS PHASE 1
-  PROPOSED STORM DRAIN IMPROVEMENTS PHASE 2A
-  PROPOSED STORM DRAIN IMPROVEMENTS PHASE 2B
-  REMOVE OR ABANDON

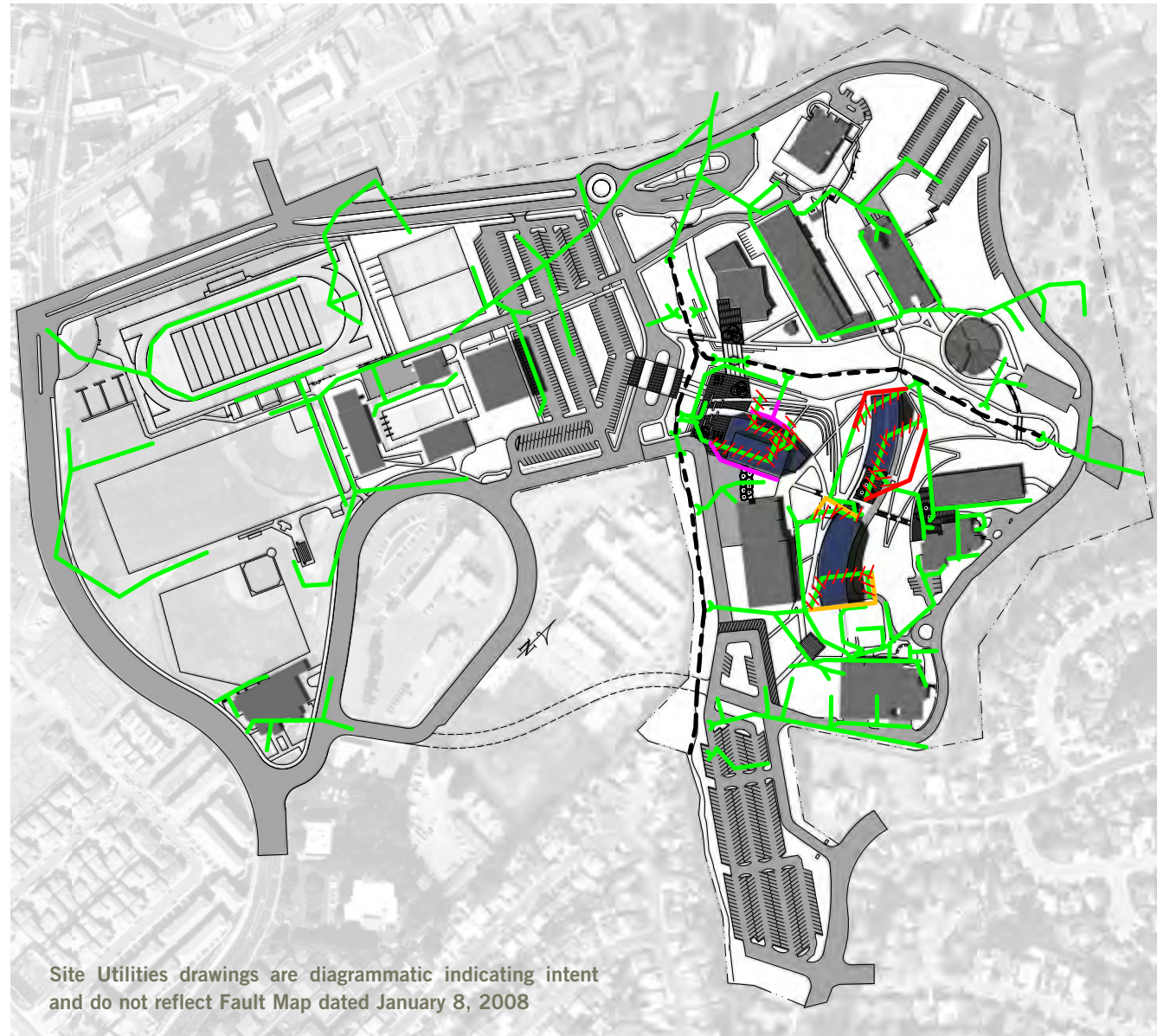

Site Utilities drawings are diagrammatic indicating intent and do not reflect Fault Map dated January 8, 2008

WATER DISTRIBUTION SYSTEM

- EXISTING PUBLIC WATER MAIN
- - - EXISTING CCC FIRE WATER LINE
- EXISTING CCC WATER LINE
- PROPOSED FIRE WATER LOOP
- PROPOSED WATER LINE PHASE 2A
- PROPOSED WATER LINE PHASE 2B
- /// REMOVE OR ABANDON
- ⊕ EXISTING METER AND SERVICE CONNECTION
- EXISTING VALVES AND FIRE HYDRANTS NOT SHOWN

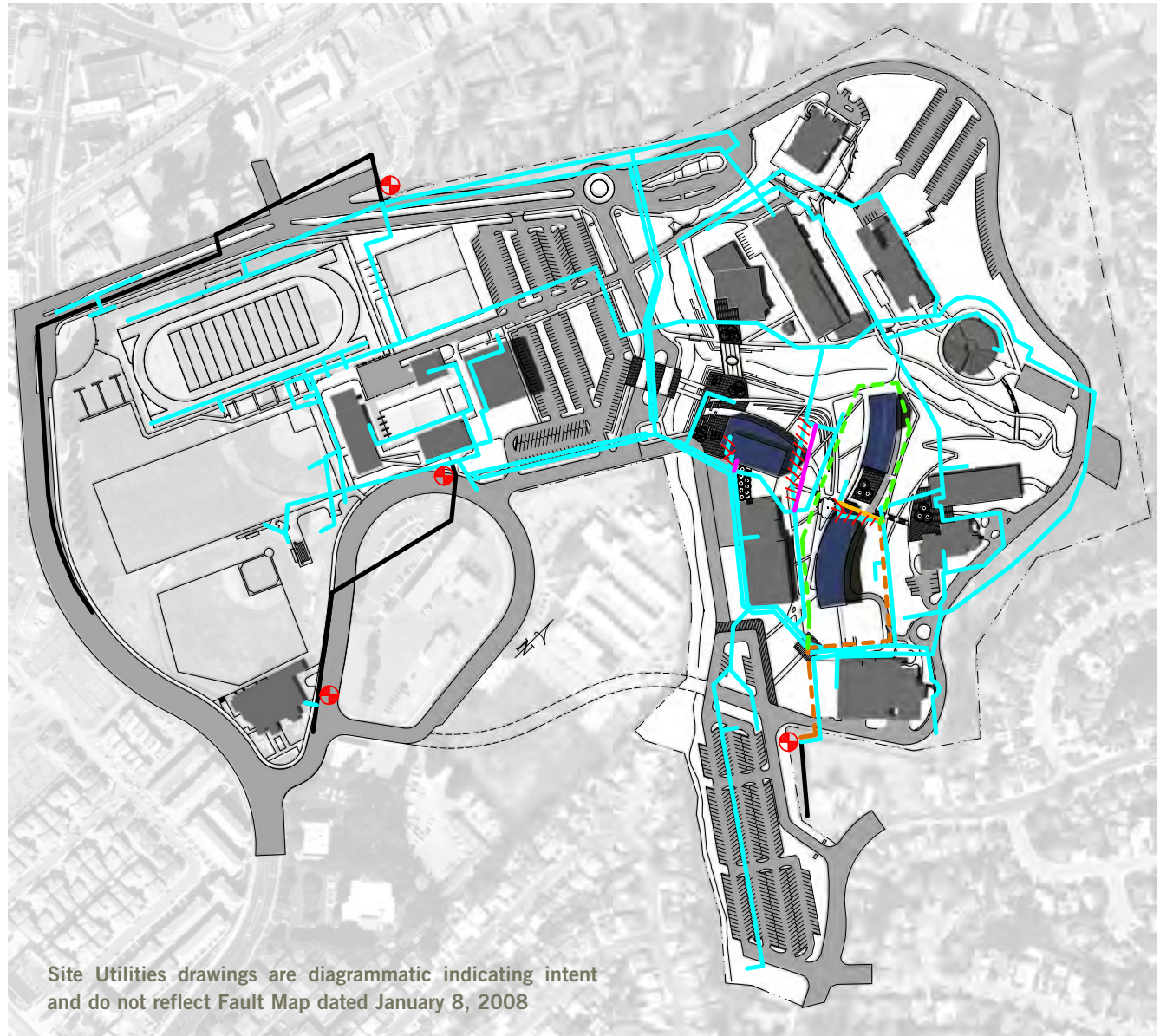

Site Utilities drawings are diagrammatic indicating intent and do not reflect Fault Map dated January 8, 2008

CAMPUS GUIDELINES, SYSTEMS AND STANDARDS

5.1. General Overview

General Overview

Campus Standards and Design Guidelines define architectural character and building materials and systems, and establish siting and development standards for future academic buildings respectively.

Building Standards (Sections 5.1-5.2) establish siting and development standards for future buildings. Visual continuity with the existing campus buildings is a critical concern of the College Council and the Presidents Cabinet. Variability in form and massing is united by a fixed color and material palette.

Building Form (Section 5.3) is a direct expression of the instructional and service programs shaped in response to local climatic conditions. Building orientation recognizes this context and is planned to promote interaction.

Building Components and Materials (Section 5.4) will be selected to further acknowledge the relationships described above. In general, exterior materials are selected for durability and maintainability as well as aesthetic contribution to the campus.

Code, Life Safety and Accessibility (Section 5.5) issues have been studied to determine general feasibility and potential cost implications of the design concept.

Major building systems, structural, mechanical and plumbing, electrical, data, audio visual and telecommunications, and acoustics (Section 5.6-5.12) are presented here for review and to begin cost modeling.

Sustainability Goals (Section 5.13) include both the comprehensive LEED (Leadership in Energy and Environmental Design) certification process and general recommendations for sustainable or energy conserving design features that have proven successful on past projects.

Site Planning Standards (Sections 5.14-5.23) provide a framework to ensure that basic infrastructure elements such as roadways, parking lots, landscape, outdoor use areas, and site utilities will be functionally integrated throughout the site.

Signage Standards (Section 5.24) will maintain the identity of the Contra Costa College and to ensure that subsequent development meets or exceed these standards. Exterior signage is intended to lend dignity and character to the campus, and by incorporating materials used in the buildings themselves to provide important smaller-scale elements on the site.

Exterior Lighting Standards (Section 5.25) ensure that site lighting supports the landscape, building and signage design concepts. Lighting is used to define outdoor use areas, to articulate natural and built features, and to address site safety and security. These guidelines are undertaken within LEED standards to minimize environmental impact.

Master Plan Design Guidelines

The core area of redevelopment proposed in the Master Plan is in the central campus area. Buildings are massed to reinforce existing pedestrian corridors and define outdoor use areas such as an amphitheater and exterior plazas for social functions. Although the diagrammatic Master Plan graphics depict curved plan shapes for the buildings', the final building plans will not necessarily reflect these curved shapes. Buildings are separated based on their function, appropriate contextual scale, and phasing in construction.

Most social functions of the campus including Student Services, Student Life, Administration, the Café, and Bookstore will be located near the new main outdoor plaza and drop-off. The overall site massing strategy is to reinforce the importance of these interaction areas with the liveliest massing and greatest detailing.

Bond funding requirements require relatively high efficiency ratios (Net to gross area). Programmatic expression must be relatively straightforward. Formal expression may be achieved through projecting roofs that provide passive cooling, weather protection, and define outdoor use areas.

Development Standards for Height and Massing

- The CCC campus is technically exempt from local ordinances establishing maximum height of buildings. Accordingly, the Master Plan does not impose height limits. However, it is the intent to generally comply with the underlying zoning and regulatory constraints that would exist in the site were it being reviewed by the local jurisdiction.
- No new buildings shall exceed 3-stories in height. The maximum height of any building on the site is 55 feet excluding mechanical roof screens. This will accommodate three 16-foot floor-to-floor levels covered by sloping roof forms.
- Variation in height and massing is encouraged. Extending building elements such as stair or elevator towers to serve as landmark features is encouraged.

- Rooftop enclosures for mechanical apparatus will generally be part of the roof forms. If open roof screen areas are required, they will not be considered in overall building height. Height shall be as tall as necessary to completely screen mechanical equipment.
- Consistent floor heights are desirable campus buildings. Variation in the level of the building floor pads is accepted however, in order to utilize the natural topography of the site and to effectively reduce the need to import engineered fill and associated construction costs.
- Stepped and offset building planes will be employed to aid in climate control by passive shading, and to add visual interest and reduce scale.
- Buildings will be sited and configured to create pedestrian plazas and courts and to define the edges of the central plaza area.

CAMPUS GUIDELINES, SYSTEMS AND STANDARDS

5.3. Building Setbacks Guidelines

Master Plan Design Guidelines

Building Setbacks establish the fundamental relationships to adjacent buildings, to the street edge, to surrounding perimeter conditions, and to site features. Internally, building setbacks define the scale of pedestrian outdoor spaces and allow room for open space corridors. They are important externally because they set distances from which the project will be viewed from adjacent uses, such as other campus buildings and plazas.

Appropriate setbacks from property and open space lines should be established to allow for landscape and open space corridors, landscape buffers, preservation of desirable views and spatial separation from adjacent roadways.

Development Standards for Setbacks

- Municipal requirements for setbacks from property lines or easements will be maintained.
- Actual setbacks between buildings will be subject to the minimum health and safety standards contained in the California Building Code, the Uniform Fire Code, and subject to the State Fire Marshall and local fire department jurisdiction.
- Buildings must maintain a minimum of 10' landscape setback from sidewalks except at entry/ plaza locations.
- Buildings must maintain a minimum 40' setback from parking areas or roadways except at designated service points or drop-off areas.

Master Plan Design Guidelines

Expression of Content

Contextual response is balanced with the goals of providing identity for the college. Context can be seen as a response to climate and academic culture as well as the surrounding built environment. The resulting architectural concept should reveal or express the building's contents.

By far the most direct and effective means to do this is by literal transparency—being able to see the inherently interesting activities associated with the instructional programs. The particular challenge here is that audiovisual projection systems may be daylight intolerant, and that wall space provides valuable location for equipment and display. While strategic location of program elements can overcome this, a comprehensive solution is to approach all materials as contributors to this effort.

Building Features

Open Base is a component of the vertical hierarchy. A relatively glassy base with brick or brick colored cement panels can establish a greater connection with adjacent landscape and provides a sense of lightness.

Mid-level development is more neutral, differentiating between base and top. This level at the second and third stories is composed of window area and cement plaster. Articulated shade elements respond to solar exposure and provide visual interest in this zone.

Mechanical equipment screens and plenums are integrated with projecting shade canopies to form distinctive profiles at the roof line. The relatively quiet character proposed for the building lower levels is given counterpoint by these more expressive roof elements.

Additive elements are building features that lend coherence and provide more intimate scale. These include external stairs, canopies and covered walks.

The following Architectural Guidelines establish standards that will remain applicable over the time period required for complete development of the site. The intent is to insure that buildings adhere to the overall objectives of the Master Plan, and meet a comprehensible set of aesthetic, technical and functional criteria.

CAMPUS GUIDELINES, SYSTEMS AND STANDARDS

5.5. Building Components and Materials

Master Plan Design Guidelines

Development of building form will be undertaken in the succeeding design phase. The selection of exterior materials contributes to this process, however, and should be established at a conceptual level. To standardize some components and to assist in cost modeling, key building areas and primary construction materials are described in the following section.

Similarly, key interior finish standards are also outlined in this section in order to standardize some components and create continuity between all new buildings on the campus. Because such factors as availability, LEED or sustainable design contributions, and appropriateness to the design all contribute to the selection of a building's interior palette and finishes, specific product and color selections are not included here. A suggestion for actual product selections available at the time of this Master Plan are included in Appendix Section 6.3 for reference.

Exterior building material colors should be contextual with the existing campus buildings. See Appendix Section 6.7 for Color Standards.

Exterior Materials

Structural Steel

Structural Steel is assumed to be the primary structural system for the buildings. The buildings will be Type II, 1 Hour rated construction, so there will be spray fireproofing on most of the structural members. There may be roughly 20% of the construction that is Type II Non-rated construction, however. The associated fireproofing would therefore be deleted in such cases.

Concrete Masonry

Concrete masonry or brick masonry will be a primary system exterior cladding material on all new structures. The brick shall be red in color and contextually blend with surrounding buildings.

Cement Plaster

Cement plaster will be a primary system exterior finish on all new structures. The cement plaster color shall be warm gray in color and contextually blend with surrounding buildings. No EIFS (exterior insulated finish system) type products are to be utilized in any location on any new building structures.

Storefront Glazing

The glazing elements will be constructed of standard storefront glazing systems. Each floor's glazing will be self supported, and not hung. The cantilevered slab edges will provide the support for the second floor glazing. The standard color for storefront glazing on all new buildings shall be a silver metallic color. The glazing standard will be 1" clear insulated units with a low-e-coating and blue-green tint.

Composite Metal Panels

Metal cladding systems will be utilized as secondary cladding in soffit, spandrel, fascia, and roof screen areas only. Panel finish and color will be coordinated with storefront glazing systems. Penthouse enclosures will be integrated with shaped roofs and facades.

Sunscreens

The buildings will employ a simple but effective response to climate with passive solar shading techniques. Perimeter circulation elements (walking decks, balconies) may articulate portions of the buildings, and contribute to an overall shading strategy.

Other Exterior Wall Components

Other cladding and closure methods will be considered. These may include a combination of extruded mullion caps, perforated metal screens and metal grilles.

Roofs

For cost purposes, two roofing systems are thought to be potential: standing seam metal and built up. Standing seam metal roofs will be prefinished “Galvalume” or similar type product, and relate to the metal panel/ mullion systems described in the preceding paragraphs. The roofing of the mechanical equipment wells will be of concrete slab with built up roofing and a mineral cap sheet. A cost alternative will be for all built up roofing with white mineral cap sheet, smooth finish, and will require additional care of installation.

Interior Finishes

Entry Lobbies

The Contra Costa College site includes a variety of pedestrian paths with rich connections to a multitude of buildings on the campus. These campus paths connect entry lobbies of buildings with a variety of characters but with the same intention of providing a welcoming and high quality learning environment.

- Floor/Base: stone or terrazzo with stone or terrazzo base
- Walls: painted gypsum wallboard with 50-percent feature wall material such as wood panel
- Ceiling: painted gypsum wallboard, acoustical tile or metal panel in metal grid

Corridors

Corridors serve many functions in addition to their basic use for exit and access. These can become highly interactive areas by incorporating adjacent spaces for conversation and display. Interior glazing can provide indirect daylight, and connecting views to the classrooms.

Corridors may be used for routing some utilities and building services. Exposing these systems and the use of feature ceiling materials (such as accessible metal panels) will physically distinguish these areas while allowing most maintenance access to occur outside of the instructional areas.

- Floor/Base: resilient sheet flooring or carpet tile with rubber base
- Walls: painted gypsum wallboard with glass as allowed at labs, offices, and conference rooms
- Ceiling: painted gypsum wallboard, acoustical tile or metal panel in metal grid

Stairs

Like corridors, stairs offer potential for interaction. Perimeter locations will encourage use and allow them to become sculptural elements in the building composition. Durability is the primary selection criteria for wall and floor materials. Stairs will be exposed steel frame with welded steel handrails.

- Floor/Base: terrazzo or concrete treads with terrazzo or painted steel risers and stringers
- Walls: painted gypsum wallboard
- Ceiling: painted gypsum wallboard

Elevator Lobbies

- Floor/Base; stone or terrazzo with stone or terrazzo base
- Walls: painted gypsum wallboard
- Ceiling: painted gypsum wallboard, acoustical tile or metal panel in metal grid

Passenger Elevators

- Floor/Base: resilient sheet flooring or carpet tile
- Walls: plastic laminate or metal
- Ceiling: plastic laminate or metal
- Lighting: modified standard cab lighting

CAMPUS GUIDELINES, SYSTEMS AND STANDARDS

5.5. Building Components and Materials

Freight Elevators

The freight elevators will be placed in proximity to receiving areas.

- Floor/Base: resilient sheet flooring
- Walls: metal
- Ceiling: metal
- Lighting: modified standard cab lighting

Teaching Laboratories

These rooms must accommodate extended occupancy, providing occupant comfort in a technically demanding setting.

- Floor/Base: resilient sheet flooring with self coving base
- Walls: painted gypsum wallboard
- Ceiling: acoustical tile in metal grid
- Audio Visual: electronic whiteboards, smart panels ,projection screen, overhead projector, assisted listening

Classrooms

These rooms must accommodate extended occupancy, providing occupant comfort in a technically demanding setting.

- Floor/Base: carpet tile with rubber base
- Walls: painted gypsum wallboard
- Ceiling: acoustical tile in metal grid
- Audio Visual: electronic whiteboards, smart panels, ,projection screen, overhead projector, assisted listening

Offices

- Floor/Base: carpet tile with rubber base
- Walls: painted gypsum wallboard
- Ceiling: acoustical tile in metal grid

- Audio Visual: electronic whiteboards, smart panels, projection screen, overhead projector, assisted listening

Conference Rooms

- Floor/Base: carpet tile with rubber base
- Walls: painted gypsum wallboard
- Ceiling: acoustical tile in metal grid
- Audio Visual: electronic whiteboards, smart panels, projection screen, overhead projector, assisted listening

Break Rooms

The areas are typically characterized by high-interactive capacity. Locating on the building perimeter will encourage use.

- Floor/Base: resilient sheet flooring or carpet tile with rubber base
- Walls: painted gypsum wallboard
- Ceiling: painted gypsum wallboard

Toilet Rooms

- Floor/Base: ceramic tile
- Walls: painted gypsum wallboard and ceramic tile
- Ceiling: painted gypsum wallboard

Loading Docks / Mechanical Spaces

The areas should be located for easy access to the service road.

- Floor/Base: sealed concrete
- Walls: sealed concrete or brick masonry units
- Ceiling: exposed structure

Master Plan Design Guidelines

Basis of Analysis:

The current code, the California Building Code (CBC), 2001 edition is the basis of code analysis presented in this Master Plan. It is anticipated, however, that California will adopt a modified version of the 2003 International Building Code (IBC) within the next year. A re-evaluation of this code analysis based on current codes at each phase is required.

Applicable Codes:

1. California Building Code (CBC) 2001
2. California Mechanical Code (CMC) 2001
3. California Plumbing Code (CPC) 2001
4. California Fire Code (CFC) 2001
5. California Electrical Code (CEC) 2004
6. State of California Code of Regulations (CCR), including “Title 24” Energy Efficiency Standards
7. Division of the State Architect (DSA)
8. Local fire marshal requirements

New Buildings and Construction Type:

1. Classroom Building- Type II 1 hour, mixed occupancy, fully sprinkled
2. Sciences and Allied Health Building- Type II 1 hour, mixed occupancy, fully sprinkled
3. Student Life Center- Type II 1 hour, mixed occupancy, fully sprinkled

Occupancy Classifications:

1. Occupancy Group: mixed B and A-3. A-3 for classrooms and lobbies with occupant loads greater than fifty and less than 300 without fixed seats.
2. Occupant Load Factors: classroom 20sf/person, school shops and vocational rooms 50sf/person, assembly areas, less concentrated use 15sf/person

General Building Limitations:

Location on Property:

New buildings will be surrounded by yards or public ways on four sides of the buildings (CBC 503.1). All are to be more than 80’ to surrounding buildings. There are no requirements for exterior wall or opening protection for all sides of building areas if this requirement is met.

Allowable Floor Area:

Mixed use occupancy allowable area limitations (CBC 504.3) are based on the actual ratio of each separate occupancy and Table 5-B. For this purpose the more restrictive A-3 Occupancy Type II 1 hour requirements are presented here.

Increase for automatic sprinkler system (CBC 505.3) not taken for area increase. Increase for separation on all sides (CBC505.1.3) is taken. Area of a multistory building may be twice that permitted by Table 5-B for one-story buildings (CBC 504.2.)

Total maximum Classroom Building	54,000gsf
Total maximum Sciences and Allied Health Building	54,000gsf
Total maximum Student Life Center	54,000gsf
Total Allowable Area:	162,000gsf

CAMPUS GUIDELINES, SYSTEMS AND STANDARDS

5.6. Code, Life Safety and Accessibility

Maximum Height of Building

The number of stories allowed for A-3 Occupancy, Type II 1 hour: (more restrictive than B) per CBC Table 5-B are shown here. Increase for automatic sprinkler system (CBC 506) is taken for story increase.

No. of stories permitted for A-3 occupancy: 3

Requirements Based on Type of Construction:

1. *Construction Type II 1 hour*
2. *Fire Resistance Ratings of Structural Elements per CBC Tables 5- and 6-A:*
 1. Bearing Walls – Exterior ('A-3'): 2Hr NC less than 5' 1Hr NC elsewhere
 2. Bearing Walls – Exterior ('B'): 1Hour NC
 3. Bearing Walls - Interior: 1Hour NC
 4. Nonbearing Walls - Exterior: **Same as bearing
 5. Structural Frame: 1 Hour
 5. Partitions - Permanent: ***NC
 6. Shaft Enclosures: 1 Hour
 7. Floors and Floor-ceilings: 1-Hour Fire Rated
 8. Roofs and Roof-ceilings: 1-Hour Fire Rated Exterior Openings: See sec. 602.3.2
 9. Stairway Construction: Non-combustible and See sec. 602.4

* The exterior wall construction must be a minimum 4-hour rated construction when located less than 5'-0" from the assumed property line. Refer to table 5-A for all requirements.

** Same as bearing except NR NC 40 Feet or greater. Refer to CBC table 5-A and 6-A for all requirements.

***Non-rated partitions are required to be constructed of materials required for 1 hour construction but are not required to be rated.

Note: Exterior Opening Requirements: Openings less than 5' from assumed or real property lines are not permitted. 1 hour rating of openings is required when less than 20' to assumed or real property lines.

Exiting Requirements:

1. Per Section 304.2.2.1 for Group B Occupancy, every laboratory having a floor area of 200 square feet or more requires at least two separate exits or exit access doors and all portions of the room shall be within 75 feet of an exit. Per Exception 4 to Section 1004.2.2, only one such access to exit may be through an intervening room; all other access to exits must be directly from the lab to an exit corridor. See tables below for Occupant load calculations and exit width requirements.
2. Exterior Exit balconies: Exterior exit balconies are permitted in the Atrium. Up to 100' travel distance as allowed by Section 1004.2.5 may be an open exit access balcony within an atrium. Up to 50% of the Atrium may exit through a horizontal exit.
3. Corridors: Most circulation areas will probably be rated corridors rather than hallways since laboratories over 200sf require 2 exits. One exit must connect directly to a rated exit enclosure. Laboratories are also required to be within 75' of a (rated) exit. Any break areas will need approval from the State Fire Marshall if placed in rated corridors.
4. Hallways: Discrete office areas could have hallways in lieu of corridors if separated from (rated) corridors.
5. Stairways: Require .3 inches width per occupant emergency access per CBC Table 10B.

Accessibility Requirements

Stairs, door hardware, and restrooms in the building shall be compliant with ADA/ California Title 24 requirements. The access to upper floors is provided by elevator typically.

Plumbing Fixture Count

The basis of design is the 2001 CBC. It is within the jurisdiction of CCC to determine if the 2001 CBC or the 2001 UPC is applicable. Fixture counts for each code will vary.

Chemical Inventory

Contra Costa Community College District will provide a chemical inventory for review by DSA for the Sciences and Allied Health Building.

Based on review of the hazardous inventory a determination will be made as to whether the quantities of the various categories of materials fall within the permitted quantities for classification of the laboratory spaces as a Group B occupancy. This will require amounts in excess of legal maximums for Group B occupancies to be stored in separate H accessory occupancy closets. A detailed chemical inventory analysis will be required prior to filing for permit with the DSA.

The campus will establish procedures for the regular pick up and disposal of hazardous materials from the teaching laboratories. These materials will be stored to allow for secondary containment in the event of accidental spills.

CAMPUS GUIDELINES, SYSTEMS AND STANDARDS

5.7. Structural Systems

The proposed additions to the Contra Costa College include the following:

- A three-story, 60,000 gsf classroom building to be constructed on the site of the current Humanities building. The building footprint will be approximately 248'x73' with structural bays spaced at 35'x35'.
- A three-story, 48,000 gsf science and health sciences building to be constructed on the site of the current Liberal Arts and Health Sciences Buildings. The building footprint will be approximately 248'x73' with structural bays spaced at 35'x35'.
- An administration and student association building built on the site of the current Student Association Building. This building will consist of two 18,000 gsf floors (36,000 gsf total).

The buildings will be designed to comply with Type II non-rated more restrictive construction.

Due to fault presence on the campus, all new building sites will be “cleared” per the Alquist-Priolo Special Studies Zone Act. The sites for the existing Liberal Arts, Health Sciences, and Humanities Buildings have been “cleared” by previous trenching, but the current Student Association building site has not yet been “cleared”.

Superstructure

Gravity System:

The gravity framing of the structures will consist of metal deck roof and floors with light weight concrete fill at the floor levels. The decks will be supported by steel beams and girders, designed to act compositely at the floor levels. This framing will in turn be supported by steel columns.

In addition to meeting the strength and deflection requirements of the CBC, the floors of the new science and health sciences building will be designed to

meet certain vibration criteria, utilizing the document “Floor Vibrations Due to Human Activity” by the American Institute of Steel Construction, Inc. (AISC Design Guide 11). The recommended design criteria will be to limit vibrational velocity to 4,000 micro-inches per second (mips) for the building.

Lateral System:

Option 1: Steel Moment Frame

Steel moment frames allow for an open floor plan with no obstructions between bays, for maximum architectural flexibility. Overall Structural stiffness for lateral (i.e. earthquake) forces is harder to achieve with moment frames. Larger lateral displacements in the building can cause more non-structural damage during an earthquake. Moment frame beams and columns are frequently larger sections and occupy many of the bays in a building, often causing the structure to be a more costly.

Option 2: Steel Braced Frame

Steel braced frames provide more lateral stiffness for a building. Braced frame systems are typically comprised of lighter beam and column sections, providing significant cost savings. The increased stiffness also leads to lower lateral displacements and subsequently less non-structural damage following an earthquake. Braced frame diagonals can impede some architectural elements, mainly in door and window placement. However, these obstructions can be minimized and braces can be easily incorporated into plans early in the design process.

Substructure

Subsurface investigations yielding foundation design and construction recommendations for this site have not been performed at this time. The following assumptions are based upon the structures currently occupying the sites.

Foundations: Conventional spread footings and grade beams may be used.

Ground Floor Slab: The ground floor slabs may consist of slabs-on-grade. “Building pad” preparation requirements will be provided.

Design Criteria

Code: 2007 California Building Code (CBC)

The 2007 CBC will be formally enforced as of January 1st, 2007. It is based on the 2006 International Building Code (IBC)

Wind Loads (Simplified Procedure):

Basic Wind Speed (3-second gust)	85 mph
Exposure Category	C
Height and Exposure Adjustment Factor	λ = Function of mean roof height
Topographic Factor	$K_{zt} = 1.0$ (for flat site)
Simplified Wind Pressure	p_{s30} = Varies with building element
Wind Importance Factor	$I = 1.15$
Wind Pressure	$p_s = \lambda K_{zt} I p_{s30}$

Seismic Loads:

Please note that exact seismic parameters will be determined by geotechnical investigation of the sites.

Seismic Design Category	E
Mapped Acceleration Parameters	S_s S_1
Site Class	D (assumed)
Site Coefficients	F_a F_v
Adjusted Acceleration Parameters	$S_{MS} = F_a S_s$ $S_{M1} = F_v S_1$
Design Acceleration Parameters	$S_{DS} = 2/3 S_{MS}$ $S_{D1} = 2/3 S_{M1}$
Seismic Importance Factor	$I = 1.25$
Seismic Weight	W
Structural System	Special Steel Concentrically Braced Frame $R = 6$ $\Omega_o = 2$ $C_d = 5$
	Special Steel Moment-resisting Frame $R = 8$ $\Omega_o = 3$ $C_d = 5 \frac{1}{2}$
Equivalent Lateral Force Procedure: Base Shear	$V = C_s$ $W = \frac{S_{DS} W}{R / I}$

CAMPUS GUIDELINES, SYSTEMS AND STANDARDS

5.7. Structural Systems

Design Load Combinations:

Strength Design or Load and Resistance Factor Design (LRFD):

$$1.4D$$

$$1.2D + 1.6L + 0.5Lr$$

$$1.2D + 1.6Lr + (f_1L \text{ or } 0.8W)$$

$$1.2D + 1.6W + f_1L + 0.5Lr$$

$$1.2D + 1.0E + f_1L$$

$$0.9D + 1.6W$$

$$0.9D + 1.0E$$

Where

$$E = E_h \pm E_v$$

$$E_h = \rho QE$$

ρ = Redundancy Factor

$$E_v = 0.2 S_{DS} D$$

$f_1 = 1.0$ (for public assembly or live loads in excess of 100 psf)

$= 0.5$ (for other live loads)

Special Seismic Load Combinations:

$$1.2D + f_1L + E_m$$

$$0.9D + E_m$$

Where $E_m = E_{mh} + E_v$

$$E_{mh} = \Omega_o Q_E$$

Materials:

Structural Steel:

Wide Flanges and Tees: ASTM A992, Grade 50

Base Plates and Gusset Plates: ASTM A572, Grade 50

Channels, Angles, Misc. Plates, etc.: ASTM A36

Hollow Structural Sections (square): ASTM A500 Grade B

Hollow Structural Sections (round): ASTM500 Grade B

Concrete:

Foundations: $fc' = 3,000$ psi, weight = 145 pcf

Slab on Grade: $fc' = 3,000$ psi, weight = 145 pcf

Fill Over Metal Deck: $fc' = 3,000$ psi, weight = 110 pcf

Reinforcing: ASTM A615, Grade 60

CAMPUS GUIDELINES, SYSTEMS AND STANDARDS

5.8. Mechanical, Plumbing and Fire Protection Systems

Codes and Standards

Systems shall be designed in accordance with the latest edition of the following codes. The latest edition currently available is noted for reference only.

1. California Building Code (CBC) 2001
2. California Mechanical Code (CMC) 2001
3. California Plumbing Code (CPC) 2001
4. California Fire Code (CFC) 2001
5. California Electrical Code (CEC) 2004
6. State of California Code of Regulations (CCR), including “Title 24” Energy Efficiency Standards
7. Division of the State Architect (DSA)
8. Local fire marshal requirements

Reference standards of the following shall be used for design.

1. ADA – Americans with Disabilities Act
2. AMCA – Air Movement and Control Association International, Inc.
3. ANSI – American National Standards Institute
4. ARI – Air Conditioning and Refrigeration Institute
5. ASHRAE – American Society of Heating, Refrigerating, and Air Conditioning Engineers
6. ASME – American Society of Mechanical Engineers
7. ASSE – American Society of Sanitary Engineering
8. ASTM – American Society for Testing and Materials
9. AWS – American Welding Society
10. AWWA – American Water Works Association
11. CISPI – Cast Iron Soil Pipe Institute
12. EPA – Environmental Protection Agency

13. NEMA – National Electrical Manufacturer’s Association
14. NFPA – National Fire Protection Association
NFPA 13 – Installation of Sprinkler Systems
NFPA 14 – Standpipe and Hose Systems
15. NSF – National Sanitation Foundation
16. PDI – Plumbing and Drainage Institute
17. SMACNA – Sheet Metal and Air Conditioning Contractors’ National Association
Fire, Smoke and Radiation Damper Installation Guide for HVAC Systems
Seismic Restraint Manual: Guidelines for Mechanical Systems
HVAC Duct Construction Standards
17. UL – Underwriters’ Laboratories
18. USGBC – United States Green Building Council’s LEED Guidelines

CAMPUS GUIDELINES, SYSTEMS AND STANDARDS

5.8. Mechanical, Plumbing and Fire Protection Systems

Mechanical

Design Criteria

Location: San Pablo, California

Latitude: 37.6°N

Elevation: 30 ft

Outdoor Design Conditions (ASHRAE Climatic Data Region X)

Non-Laboratory Spaces

Summer

Design Temperature: 84°F DB / 63°F WB (ASHRAE 0.5%)

Outdoor Daily Range: 17°F DB

Design Wet Bulb: 66°F WB (ASHRAE 0.5%)

Winter

Design Temperature: 34°F DB (ASHRAE 0.2%)

Median of Extremes: 29°F DB

Laboratory and Support Spaces

Summer

Design Temperature: 90°F DB / 65°F WB (ASHRAE 0.1%)

Outdoor Daily Range: 17°F DB

Design Wet Bulb: 69°F WB (ASHRAE 0.1%)

Winter

Design Temperature: 34°F DB (ASHRAE 0.2%)

Median of Extremes: 29°F DB

Indoor Design Conditions

	Cooling (°F)	Heating (°F)	Relative Humidity (%)
Classrooms	72 ± 2	68 ± 2	No Control
Offices	72 ± 2	68 ± 2	No Control
Laboratories	72 ± 2	68 ± 2	No Control
Laboratory Support	72 ± 2	68 ± 2	No Control
Computer Labs	72 ± 2	68 ± 2	No Control
Library/Media Center	72 ± 2	68 ± 2	No Control
Kitchens	72 ± 2	68 ± 2	No Control
Server Rooms	72 ± 2	68 ± 2	20 – 80 (ASHRAE)
Shop Areas	None	68 ± 2	No Control
Mechanical Rooms	80 ± 2*	65 ± 2	No Control
Electrical Rooms	80 ± 2*	65 ± 2	No Control
Telecomm Spaces	80 ± 2**	None	No Control

*May be ventilated only; need for cooling to be determined by designer.

**Cooled only if they contain equipment; telephone backboards ventilated only.

Envelope Load Assumption

Walls:	R-19 insulation to provide a minimum composite R-Value of R-11
Roofs:	R-30 insulation to provide a minimum composite R-Value of R-19
Glazing:	Single or double pane per architectural drawings Title 24 Climate Zone 3

CAMPUS GUIDELINES, SYSTEMS AND STANDARDS

5.8. Mechanical, Plumbing and Fire Protection Systems

Ventilation Rates

Laboratories:	6 air changes / hour, 100% outside air
Laboratory Support:	6 air changes / hour, 100% outside air
Toilet Rooms	12 air changes / hour
Other Areas	Title 24 requirements

Night setback ventilation rates shall be considered for laboratory and support spaces.

Laboratory and support space air pressures shall be maintained negative with respect to surrounding spaces.

Filtration shall be 85% efficiency for laboratory and support spaces and 35% efficiency for other spaces.

Interior Loads

Cooling loads shall be calculated during design. The following approximate values are for estimating purposes.

Laboratories:	20-30 Btuh/ft ²
Laboratory Support:	50-75 Btuh/ft ²
Classrooms:	50-80 Btuh/ft ²
Offices:	20-30 Btuh/ft ²

Heating, Ventilating, and Air Conditioning

Heating

A district heating system serving the campus core provides 140°F to 180°F for space heating. Buildings in this area should use this system. Heating systems that should be considered include radiant floor, central VAV system with zone reheat coils, individual fancoil units, and perimeter induction units.

Ventilating

Natural ventilation shall be considered for all spaces. Mechanical ventilation shall be provided as required by code. Shop areas shall be cross-ventilated using motorize clerestory windows for intake and wall- or roof-mounted fans located at high bay for exhaust. Fans to supply untempered makeup air to special areas such as welding, paint spray booths, and vehicle exhaust shall be interlocked with the exhaust systems.

Air Conditioning

Air conditioning systems that should be considered include air- or water-cooled chillers, package rooftop air conditioning units, and central VAV systems. Non-ozone depleting refrigerants such as R410a shall be used.

Ductwork

Ductwork fabrication and installation shall follow SMACNA and ASHRAE guidelines. Ductwork shall be galvanized sheet metal. Laboratory exhaust ductwork shall be 304 or 316 stainless steel or fiberglass reinforced plastic.

Supply duct construction and sealing shall meet SMACNA medium pressure (4"wg) standards. Return air and general exhaust duct construction and sealing shall meet SMACNA low pressure (2"wg) standards. Laboratory exhaust duct construction and sealing shall meet SMACNA high pressure (6"wg) standards with welded seams.

Flexible ducts shall be used only for final connection to supply diffusers. They shall be pre-insulated with vapor barrier and a maximum of 6'-0" in length. Ductwork shall be insulated as required by Title 24. Internal lining shall be avoided if possible in laboratory and support space supply air ductwork.

CAMPUS GUIDELINES, SYSTEMS AND STANDARDS

5.8. Mechanical, Plumbing and Fire Protection Systems

Diffusers and Grilles

General spaces shall be provided with perforated face diffusers similar to Titus PSS for supply and Titus PAR for return. Sidewall diffusers shall be louvered grilles similar to Titus 272RL for supply and Titus 25RL for return.

Laboratory supply diffusers may also be high volume and low throw similar to Titus Tri-Tec. Maximum supply air velocity near fume hoods and biological safety cabinets shall be 50 feet per minute at 6 feet above the floor.

Exhaust

Restrooms, custodial rooms, and locker rooms shall be 100% exhausted at a rate of 12 air changes / hour or 2 cfm/ft², whichever is greater. Fans shall be controlled by light switch, occupancy sensor, or timeclock through the EMS.

Electrical and mechanical rooms shall be exhausted at a rate of 1 cfm/ft² or as otherwise needed. Fans shall be controlled by line-voltage thermostats.

Special areas such as welding, paint spray booths, and vehicle exhaust shall have separate exhaust systems using hoods, snorkels, or direct equipment exhaust connections. Fans to supply untempered makeup air shall be interlocked with the exhaust systems. Flow rates for special areas depend on equipment requirements.

Exhaust fans shall have minimum 1.5" spring isolation for vibration control.

Laboratory Exhaust

Fume hood exhaust systems shall serve anatomy laboratories and those containing chemicals or toxic materials. Utility set-type exhaust fans supplied with emergency power shall be located on the roof. Air volume shall be based on the total number of fume hoods required for the program. There shall be no treatment of this air prior to discharge to atmosphere.

Discharge velocity shall be at least 3,000 feet per minute. Exhaust stacks shall be above the highest point of the building and at least ten feet above the adjacent roof line. They should not be located within enclosures or architectural screens. Architectural masking structures may be used as long as the stack extends at least one diameter above the structure.

Recirculation of exhaust air streams to outside air intakes of building ventilation systems must be prevented. It is recommended that building air intakes be located on the lower third of the building and high enough above the ground to avoid dust or vehicle exhaust. If located on the roof, air intakes should not be placed near the edges of a wall or roof. Wind tunnel or computer modeling of local wind conditions should be considered to minimize entrainment of exhaust air into this and adjacent buildings.

Space shall be designed for the addition of future exhaust air filtration.

Ductwork shall be under negative pressure. Sound absorbing lining and other devices shall not be used. Fire and smoke dampers shall not be placed in these ducts. Ducts shall be sized for an air velocity of 1,600 to 2,000 feet per minute and to maintain a minimum face velocity across the fume hood sash opening of 100 FPM as required by OSHA. A manifolded exhaust system may be used if the authority having jurisdiction agrees to use NFPA 45 instead of a literal interpretation of the CBC. All fans shall be provided with DDC controllers for tie-in to the EMS.

Energy Management System

The campus Energy Management System (EMS) is an Andover system with connections to all campus buildings. The main control location is in the Maintenance Office. The EMS also enables timeclock and local photocell control of exterior lighting.

New building EMS systems shall include complete direct digital control (DDC) to monitor and control all HVAC mechanical equipment and electrical lighting loads. They shall provide graphical displays and analysis tools, centralized alarm reporting, real time status and trending capabilities, and automatic systemwide emergency responses. They shall be directly integrated with the fire alarm and controls systems for single-seat control and monitoring and shall be UL Listed for such use. The network shall operate on a 10BaseT Ethernet Local Area Network (LAN) and allow for multiple dedicated operator workstations and remote web-based communications.

Individual DDC components shall support an open protocol environment. Typical protocols supported include LONWorks, BACNet, BACNet I/P, ModBus, ProfiBus, OPC and others. The network architecture and DDC products shall allow the implementation of a multiple-protocol communication environment.

CAMPUS GUIDELINES, SYSTEMS AND STANDARDS

5.8. Mechanical, Plumbing and Fire Protection Systems

Gateways and routers required for integration with third party systems will be acceptable. The EMS contractor shall provide all warranty and product support for one year.

Individual DDC controllers shall be provided for each piece of HVAC equipment. The network architecture shall support a modular approach to accommodate additional DDC controllers, expansion modules, or application specific controllers for terminal unit equipment, with virtually no limit to the number of devices allowed for connection on the LAN.

Simple mechanical systems may be controlled with standard manufacturer's controls packages. Connections to the campus EMS shall provide remote equipment start/stop and annunciation of operating status, heating hot water temperature, and heating zone temperature.

Meters and instrumentation shall be installed to monitor and report energy use at least at the building level and preferably for each major building system.

Controls wiring and cables shall be installed in EMT conduit regardless of application. Exposed conduit installed on roofs and exposed locations shall be RMC rigid applications.

Temperature Controls and Zoning

Individual temperature controls shall be based on function, exposure, and campus request. Each corner exposure (NE, NW, SE, and SW) shall be on a separate zone. Each conference room, lobby, classroom, book store, dining room, lobby, and break area shall be on a separate zone. Perimeter closed offices shall be provided with one zone for every three offices.

Testing, Adjusting, and Balancing

An independent AABC or NEBB certified testing and balancing contractor shall be required (as a sub-contractor to the general contractor) to balance all air and water systems and heating and cooling equipment to the required quantities and to verify the capacity and operating conditions of each piece of equipment. After completion (airflows have been balanced to within +/- 10% of design) the contractor shall submit balance reports.

Commissioning

The mechanical, electrical, and plumbing systems should be commissioned by an independent commissioning authority under separate contract directly with the campus or its representative. Determine at the beginning of each project the extent desired by the campus, and whether LEED enhanced commissioning will be included.

Energy Efficiency / Sustainability

New buildings shall be designed to outperform the requirements of Title 24 by 20%. If a building is exempt from Title 24 requirements, it shall outperform a standard building of its type by 20%.

Alternatives involving increased construction costs shall be economically evaluated to determine payback period. All assumptions used in the evaluation shall be clearly stated. To ensure that as many cost-effective measures as possible are installed, every attempt should be made to ensure that all energy conservation measures with a simple payback period of less than 10 years are installed. The design process shall include attention to energy efficiency for systems not addressed by Title 24.

Energy conservation measures for consideration include the following.

Chillers

- Limit air-cooled chiller to 30 tons
- Limit air-cooled chiller to 150 tons with thermal storage
- Limit evaporative cooled chiller to 150 tons
- Energy efficiency options

Cooling Towers

- Close approach temperature (4-7°F)
- Oversized with low fan power (<0.03 kW/ton)
- 2 speed motors for fans 1 HP and up
- VFD for fans 15 HP and up

CAMPUS GUIDELINES, SYSTEMS AND STANDARDS

5.8. Mechanical, Plumbing and Fire Protection Systems

Boilers

- Modulating or high/low fire
- Factory insulated to R-6 or better
- Energy efficiency options
- Pulse boiler

Pumps

- Provide lead/lag pumping for VFD systems (eg split 1 100% pump into 2 60%)
- Optimize selection to minimize HP
- Suction diffuser on base mounted pumps

Hydronic Systems

- For heating hot water, use 180°F hot water supply temperature for coil sizing
- Maximize delta T to reduce pump and pipe sizing
- 40 to 60°F delta T for air handling coils
- 30 to 40°F delta T for reheat coils
- Reverse return piping or pipe looping
- Pot feeders in parallel with pumps
- Limit pressure drop to 2 feet / 100 feet

Air Handlers

- VFD for VAV systems with motors 15 HP and larger; consider for 3–10 HP
- VFD for CV systems with motors 25 HP and larger using >65% efficiency filtration
- Size coils for max face velocity of 350–450 fpm and 0.40–0.55 inch pressure drop

- Optimize selection to minimize fan HP
- Casing insulation of R-8 or more
- Low leakage dampers
- Low pressure drop sound attenuation

Air Filters

- Size for max face velocity of 400 fpm and 0.17 inch initial pressure drop

VAV and CV Boxes

- For VAV systems, unless calculations indicate otherwise, set minimum air flow for cooling and for heating to 40% of max air flow, or 0.70 cfm/ ft², whichever is less
- Limit pressure drop of a bare box to 0.07 inch; add 0.10 inch for 1 row coil; add 0.15–0.20 inch for 2 row coil

Ductwork

- Prohibit splitters, extractors, scoops, and 90 degree branch taps
- Branch take-offs (rectangular to rectangular): Shoe SMACNA Fig 14-14.N or W
- Branch take-offs (rectangular to round): Conical SMACNA Fig 14-14.M or V
- Branch take-offs (round to round): Wye SMACNA Fig 14-14.B, C or J
- Limit pressure drop to 0.08 inch / 100 feet

Exhaust Fans

- Optimize selection to minimize fan HP
- Provide 5 to 10 diameters straight duct into fan
- Use propeller fans for low delta P applications

Package Units and Split Systems

- Select high SEER equipment
- Provide slightly oversized evaporator
- For multi-compressor systems, intertwine coils

Heat Recovery and Indirect Evaporative Cooling

- Consider for 100% outside air systems and other systems with high OSA rates
- Consider additional pre-cooling by spraying exhaust air coil

Motors

All motors 1 HP and over used at least 1,000 hr/yr shall be premium efficiency per requirements of NEMA MG-1, Table 12-6D Nominal Efficiency for ODP and TEFC Motors:

HP	eff	HP	eff	HP	eff	HP	eff	HP	eff
1	85.5	5	89.5	20	92.4	50	94.1	125	95.4
1.5	86.5	7.5	91.0	25	93.6	60	94.5	150	95.8
2	86.5	10	91.0	30	93.6	75	95.0	200	95.8
3	89.5	15	92.4	40	94.1	100	95.4		

Plumbing

General

Domestic hot and cold water, sewer, and vent shall be provided to fixtures including water closets, urinals, lavatories, showers, eyewashes, sinks, hose bibs, mop sinks, etc., and to shop, kitchen, or other equipment as needed. Water systems shall be designed to prevent water hammer conditions by providing air chambers or shock arrestors for fixtures, and shock arrestors for quick closing valves.

Existing fixtures in remodeled buildings shall be replaced by ADA-compliant fixtures, and water, waste, vent, and gas service and distribution piping shall be replaced.

Hose bibbs shall be provided with vacuum breakers and located in restrooms under lavatories, in mechanical rooms, in shop areas as needed, and as required on the outside of the building.

A complete set of laboratory piped services shall be stubbed out with shutoff valves for each laboratory.

A water and gas meter shall be provided at each building service entry.

Design Criteria

100 year 60-minute rainfall CPC)	1.5 inch/hour (0.016 gpm/ft ²) (1998
Maximum water flow velocity	8 ft/sec at design flow
Water pressure at fixtures	35 to 75 psi
Lab natural gas	1 cfh / outlet, no diversity
Lab compressed air	1 cfm / outlet, 60% diversity
Lab vacuum	0.5 cfm / outlet, 60% diversity

CAMPUS GUIDELINES, SYSTEMS AND STANDARDS

5.8. Mechanical, Plumbing and Fire Protection Systems

Plumbing Systems

Domestic Cold Water

Domestic cold water shall be supplied to fixtures and equipment as needed. Emergency eyewashes and showers and drench hoses shall be supplied with domestic cold water. Groups of fixtures shall be provided with isolation valves for ease of maintenance, and each fixture shall have an isolation valve. Piping shall be soldered Type L copper for 2 inches and less, and Schedule 40 galvanized steel over 2 inches. New branch piping shall be provided with branch shut-off valves.

Domestic Hot Water

Three sources for domestic hot water shall be considered during design: Solar thermal panels with a small storage tank, heat exchanger using campus loop hot water, and gas-fired water heater. Groups of fixtures shall be provided with isolation valves for ease of maintenance, and each fixture shall have an isolation valve. A return system with circulating pump shall be considered based on piping configuration and supply distances. Piping shall be the same as domestic water and insulated to Title 24 requirements.

Industrial Water

The industrial hot and cold water systems shall be supplied through backflow preventers by the domestic hot and cold water systems. Industrial water shall supply laboratory fixtures (sinks, cupsinks, hoods) and mechanical equipment requiring makeup water. Piping shall be brazed Type L copper.

Waste and Vent

Sewer and vent piping shall be provided for each non-laboratory waste fixture. This system shall also collect equipment condensate. Floor drains with trap primers shall be provided in restrooms, mechanical rooms, and elsewhere as required. Piping shall be no-hub cast iron with neoprene sleeve gaskets and 301 stainless steel clamps for sewer and vent with an option for DWV copper for 2½ inch and smaller. Underground piping clamps shall be 304 stainless steel. Condensate drain piping shall be DWV copper. All sewer and drain piping shall be sloped ¼ inch per foot.

Liquid waste from areas where oil and gasoline are present shall pass through an oil/sand trap or oil filtration system and sand trap before connection to the campus sewer.

Mechanical equipment drains from boilers, hot water heaters, and shop equipment shall be indirectly drained to the waste system at mechanical room floor drain.

Laboratory Waste and Vent

Laboratory fixtures shall be drained and vented with corrosion-resistant piping connected to a double contained limestone neutralization tank with alarm and monitoring panel and a sampling station. The tank shall drain to the sanitary sewer outside the building. Above grade piping material shall be mechanical joint or cold-fusion welded polypropylene, high silicon iron (Duriron), or glass. Below grade piping shall be cold-fusion welded polypropylene or high silicon iron (Duriron). Piping shall be sloped ¼ inch per foot.

Roof and Overflow Drainage

Roof and overflow drainage shall properly drain roof areas into the site storm drain system. Piping shall be no-hub cast iron with neoprene sleeve gaskets and 301 stainless steel clamps for sewer and vent. Underground piping clamps shall be 304 stainless steel. Piping shall be sloped ¼ inch per foot.

Natural Gas

Gas service pressure shall be reduced at the building to 7 inches water column. A seismic shutoff valve shall be provided at each building. Gas shall be distributed to water heaters, laboratory benches, and other uses as needed. Laboratory gas system shall be sized based on 1 cfh per lab outlet with no diversity. Piping shall be threaded or welded Schedule 40 black steel.

Laboratory Purified Water

Depending on the number of outlets and amount of water needed, either a central purified water system or a central reverse osmosis system with point of use deionization units may be provided. The system shall be designed as a continuous loop without dead legs, and connection lengths to faucets shall be limited to 6 pipe diameters. System water pressure shall be no more than 60 psig and water velocity at least 3 feet per second. Piping shall be cold-fusion welded non-pigmented polypropylene.

CAMPUS GUIDELINES, SYSTEMS AND STANDARDS

5.8. Mechanical, Plumbing and Fire Protection Systems

Laboratory Compressed Air

An air compressor shall provide compressed air to lab benches where required. System shall be designed for 125 psig at compressor and 90 psig in distribution line, with adjustable pressure reducing valves at laboratory points of connection above ceiling to provide 15 psig air at outlet. Air shall be oil free and dried to minus 40°F dew point with a heatless, dual bed, desiccant air drier. Air compressor package shall have air cooled, oil-free type duplex compressors. System shall be provided with a main tank and end of line surge tank and will be sized based on a 60% diversity factor and 1 cfm per lab outlet. Piping shall be Type L LOX rated copper with silver brazed joints or ABS air-line polymeric blend with solvent welded joints.

Laboratory Vacuum

A vacuum pump shall provide vacuum to lab benches where required. System shall be designed for minus 23 inches of mercury. Vacuum pump shall be a skid mounted duplex system with a liquid interceptor with drain. System shall be sized based on a 60% diversity factor and 0.5 cfm per lab outlet. Piping shall be Type L copper with silver brazed joints or ABS air-line polymeric blend with solvent welded joints.

Local laboratory vacuum pumps, if any, shall discharge into the fume hood exhaust system ductwork.

Specialty Laboratory Gases

Specialty gases shall be provided by local gas cylinder stations. Piping shall be Type L copper, ACR grade, nitrogen purged, with brazed joints for CO₂, N₂, He, and Ar. Stainless steel shall be used for ultra high purity gas piping.

Energy Efficiency / Sustainability

Energy conservation measures for consideration include the following.

Fixtures

- Low-flow fixtures
- Dual flush toilets
- Waterless urinals

- Motion sensor-activated faucets

Domestic and Industrial Hot Water

- Size recirculating pumps for a 10°F temperature drop
- Low flow showerheads without flow restrictors
- Minimum R-16 insulation for storage tanks and packaged water heaters

Compressed Air and Vacuum Pump Systems

- Do not provide once through cooling water systems
- Provide intercooled and aftercooled, 2 stage compressors/pumps for 5 HP systems and larger

Fire Protection

General

Design criteria shall be prepared for design-build installation of a wet-pipe automatic fire sprinkler system throughout a building. Design shall be based on flow and residual site main pressure test. Piping material shall be Schedule 40 black steel with threaded, mechanically coupled, or welded joints.

The system shall include service main connection; risers and drain risers; zone control valve assemblies with flow and tamper switches, drain valve, and pressure gauge; inspectors test stations; gridded or looped branch piping; and semi-recessed pendent or concealed sprinkler heads in occupied areas and standard upright brass heads in areas without ceilings. The contractor shall prepare hydraulic calculations, system design, and stamped drawings for agency approval.

Available flow information shall be reviewed to determine if a fire pump will be needed. At this time it appears that water pressure is high enough to not require one.

CAMPUS GUIDELINES, SYSTEMS AND STANDARDS

5.9. Electrical, Fire Alarm and Security Systems

Electrical

Codes and Standards

Systems shall be designed in accordance with the latest edition of the following codes. The latest edition currently available is noted for reference only:

1. California Building Code (CBC) 2001
2. California Electrical Code (CEC) 2004 (NFPA-70 National Electrical Code 2002 with State of California Amendments)
3. State of California Code of Regulations (CCR), including "Title 24" Energy Efficiency Standards (2001)
4. NFPA-72 National Fire Alarm Code (1999)
5. NFPA-101 Life Safety Code (2000)
6. ANSI A117.1 Disabled Code
7. ANSI Electrical Systems
8. State of California Code Regulations Titles 8, 17, 19, and 22, Division 7, 24 - Part 3
9. California Occupational Safety and Health Act of OSHA
10. Division of the State Architect (DSA)
11. Local fire marshal requirements

Reference standards of the following shall be used for design.

1. ADA – Americans with Disabilities Act
2. AEIC – Association of Edison Illuminating Companies
3. ASTM – American Society of Testing and Materials
4. IEEE – Institute of Electrical and Electronic Engineers
5. ICEA – Insulated Cable Engineers Association
6. NEMA – National Electrical Manufacturers Association
7. NFPA – National Fire Protection Association

8. SMACNA – Sheet Metal and Air Conditioning Contractors' National Association Seismic Restraint Manual: Guidelines for Mechanical Systems (conduit supports only)
9. UL – Underwriters' Laboratories
10. USGBC – United States Green Building Council's LEED Guidelines

Design Criteria

Electrical Service

Electrical service to the new Classroom Building and the new Science and Allied Health Building shall be derived from the existing 4000A, 277/480 volts Main Switchboard (MSB) "1" located in the Electric Vault building.

New underground feeders from the existing Main Switchboard "1" shall be extended to the building main switchboards (MSB) in the new Classroom Building and the new Science and Allied Health Building.

The existing 150KVA 12KV primary 120/208 volts secondary transformer T4 at the existing Student Activities shall be removed and 12KV feeders to the transformer be removed back to manhole #3

A new 750 KVA transformer shall be installed to feed the new Student Life Center. New 12KV feeders will be extended from the existing 12 sectionalizing terminal cabinet (STC) in manhole #3 to the location of the new transformer "T4" for the new Student Life Center.

The MSB will be dead front; indoor, front accessible. The MSB will comply with all applicable provisions of UL891 and NEMA PB-2 for low voltage distribution switchboards. Equipment short circuit ratings will be determined from the existing 12kv distribution available fault data. Exact fault current available at the point of service to be verified with campus facilities department during design.

The MSB will be constructed with silver-plated copper bars of 98% conductivity sized for 1000 amperes per square inch current density. The main circuit breaker will be molded case type with adjustable long-time delay and ampere setting, short-time delay and pickup, adjustable instantaneous

CAMPUS GUIDELINES, SYSTEMS AND STANDARDS

5.9. Electrical, Fire Alarm and Security Systems

pickup. Ground fault pickup and delay with trip indicator. Feeder breakers will be fully rated, group mounted, molded case type.

The main switchboard will incorporate an SPD (surge protective device) listed per UL 1449 2nd edition for B2 location/exposure and integral to main switchboard.

Multi-function microprocessor based meters will be provided in each new main switchboard for monitoring of system power and energy in each building.

Preliminary switchboard schedule:

1. Classroom Building: 600 amp 480/277 V
2. Science and Allied Health Building: 800 amp 480/277 V
3. Student Life Center: 1000 amp 480/277 V

Power Distribution System

Step down dry-type distribution transformers will be located in local electrical rooms to supply area 120/208 volt receptacle loads. Transformers will be dry type, 220 degree C insulation, 150 degree C rise, NEMA TP-1 compliant.

Panelboards will be surface mounted with copper bus. Provide panel directory and nameplates; door-in-door construction with separate hinge. Panel to be fully rated for the available fault current.

120/208 volt panelboards will be located adjacent to step down transformers. 277/480 volt panelboards will be located in main electrical rooms and where the distance to outer lighting outlets exceeds 200 feet.

General Purpose Power Density criteria:

1. Corridors and circulation areas:
 - a. Lighting - 0.6 watt/sf
 - b. Receptacle - 0.5 watt/sf

2. Classrooms:
 - a. Lighting - 1.6 watts/sf
 - b. Receptacle - 3 watts/sf
3. Computer labs:
 - a. Lighting - 1.2 watts/sf
 - b. Receptacle - 10 -15 watts/sf
4. Mechanical/ electrical rooms:
 - a. Lighting - 1.0 watt/sf
 - b. Power - Actual load connected or motor H.P.
5. Offices:
 - a. Lighting - 1.3 watt/sf
 - b. Power - 2.0 watts/sf
- 6.. IT rooms:
 - a. Lighting - 1.6 watt/sf
 - b. Power - 20 watts/sf
7. Conference rooms:
 - a. Lighting - 1.6 watt/sf
 - b. Power - 2.0 watts/sf
8. Allied Science Labs:
 - a. Lighting - 2.0 watt/sf
 - b. Power - 3.0 watts/sf

Demand Factors (.9 power factor)

1. Lighting 100% of total VA (continuous load)
2. Receptacles 100% of first 10 kVA plus 50% balance of total load
3. Motors 125% of largest motor plus sum of 100% of all motors.
4. Fixed equipment 100% of total VA.

CAMPUS GUIDELINES, SYSTEMS AND STANDARDS

5.9. Electrical, Fire Alarm and Security Systems

Grounding

The electrical service to each building will be provided with a grounding electrode system terminating to a wall mounted ground bus in each main electrical room. Exothermic connections will be made to this bus.

The grounding electrode system will consist of building steel, concrete encased conductor (Ufer), water main, and driven ground rods. Grounding electrodes will be interconnected and bonded to the main ground bus.

A single #3/0 grounding conductor will be extended to the TMGB from the electrical room ground bus.

Separate equipment grounding conductors will be included in all raceways and branch circuits. This includes 120/208 volt receptacle circuits, 277 volt lighting circuits, and motor circuits.

Interior Lighting Systems

Design lighting levels will be consistent with IESNA and comply with Title 24 for allowable power densities. Additional savings will be achieved through participation in the PG&E Savings-By-Design program. This program provides an incentive for building lighting power densities less than Title 24 by 15% or more.

Target illumination levels in average maintained foot-candles (measure on 30" above floor horizontal plane) will be:

Mechanical/electrical rooms: - 30 fc

Office spaces: 30-50 fc

Corridors: 10-15 fc

Classrooms: 30-50 fc

Computer labs: 30-50 fc

Storage: 10-15 fc

Restrooms: 10-15 fc

Science labs: 75-100 fc

Dual level lighting will be provided in all spaces per Title 24 where the power density exceeds .6 watts /sf, more than one fixture is used, and the room measures more than 100 square feet. Corridors are excluded from the dual level switching requirement.

In general fixtures will be lamped with T5 32 watt 4100K lamps. Classroom indirect fixtures may be configured with T5 lamps depending on final calculations and room modeling. Ballasts will be electronic, HPF, <10% THD, with a ballast factor of at least .93.

Daylighting controls will be incorporated. These will consist of sensors and dimming ballasts responsive to varying daylight conditions through building fenestration elements.

Lighting controls will comply with Title 24 and consist of occupancy sensors and low voltage relay system. Occupancy sensors will be wall mounted infrared in small offices and ceiling mounted ultrasonic in open spaces. The low voltage relay system will be programmed by timeclock for area occupancy. Local low voltage switches will be provided for user override of preset controls. Relay panels will be located in electrical rooms and will be connected to the campus BAS system for remote interface.

Lighting Fixtures will consist of the following:

Offices: 2 x 2 foot recessed 3-lamp direct/indirect fluorescent

Corridors: 2 x 2 foot recessed 2 –lamp fluorescent with acrylic prismatic lens

Classrooms: Pendant and/or recessed continuous row direct and indirect fluorescent using T5 or T8 lamping with perforated diffusers.

Computer Labs: Pendant or recessed linear continuous row direct and indirect fluorescent using T5 or T8 lamping

: Pendant and/or recessed continuous row direct and indirect fluorescent using T5 or T8 lamping with perforated diffusers

CAMPUS GUIDELINES, SYSTEMS AND STANDARDS

5.9. Electrical, Fire Alarm and Security Systems

Mech/elect. rooms:	1 x 4 foot suspended 2 lamp industrial fixture slotted for 10% uplight
Stairwells:	1 x 4 foot 2-lamp surface mounted fixture with opal lens

In addition other downlights, wall sconces, wall washers and other specialty lighting fixtures may be used in specific areas based on the spaces particular requirements.

Exterior Lighting Systems

See section 5.24 for information regarding exterior lighting.

Exterior lighting will be controlled via roof mounted photocell and timeclock through local relay panels.

Emergency Egress Lighting

Selected fixtures will be equipped with integral battery units to achieve 90 minutes of illumination during loss of normal power. Integral test switches and pilot lights will be provided.

Emergency fixtures will be unswitched and located to illuminate the egress pathway to achieve code required illumination (1 fc average) and uniformity ratios (10:1). For 3-lamp emergency fixtures the center lamp will have battery power.

Exit Lighting fixtures will be low wattage LED type. The housing will be white aluminum stencil face housing with green letters.

In multi-use conference and lecture halls where the occupancy load exceeds 50 emergency lighting will be locally controlled with automatic sensing of normal power failure conditions. Should power fail at any time the emergency lighting will be energized to full output.

Fire Alarm Signaling Systems

Each building will be designed with a local fire alarm control panel (FACP). The system will be microprocessor based and addressable. A local annunciator will be located at the point of fire department entry to the building.

Space smoke detectors will be located per code and where door holders are required. Duct smoke detectors will be located at air handling units where air flow exceeds 2000 cfm.

Manual activation will be provided with local pull stations. These will be located at exit doors, and exits into stairwells from the 2nd floor spaces.

Evacuation devices will consist of strobe and horns. Devices will be located in corridors, restrooms, classrooms, conference rooms, and similar public or meeting places. Provide synchronized strobe devices.

Fire water valve tamper switches and related water flow switched will be monitored at the FACP. The site PIV will be supervised.

Branch Circuit Wiring and Raceway

Wiring systems will consist of color coded solid copper conductors for sizes #12 and smaller and stranded copper for sizes #10 and larger. For circuiting greater than 100 feet @208/120 volts: use #10 AWG.

Raceway systems will consist of EMT conduit through except where subject to damage use RS or IMC. Final connection to motors: liquidtight flexible metal conduit.

Maintain the integrity of fire rated partitions and floors with UL listed fire stopping methods and materials.

Mechanical Systems Interface

Distribution equipment will be located in mechanical rooms and on rooftops to serve fans, chillers, and related equipment. Motor control centers will be considered where control and distribution can be centralized.

The typical voltage source configuration to motor loads will be 480 volts 3-phase 3-wire. Motors with a nameplate rating 75 HP and greater will have VFD controllers or equivalent reduced voltage starting.

Provide 120 V receptacles within 25 feet of mechanical equipment. Provide power to BMS control panels.

Provide power to new fire-smoke dampers. Duct detector relay base will shutdown related fan.

CAMPUS GUIDELINES, SYSTEMS AND STANDARDS

5.9. Electrical, Fire Alarm and Security Systems

Provide local disconnect switches at each motor where the control panel does not include an integral switch

Assistive Listening System

Permanently installed assistive listening systems will be provided for assembly and teaching areas such as classrooms, auditoriums, lecture halls, and similar spaces that have fixed seating and where audible communications is integrated to the space.

The system will consist of a rack mounted transmitter with splitter to accept input from room microphones or other sounds sources, outlets in selected seating spaces, and rack mounted antennas. The transmission media will be FM based or alternate where equivalent and suitable for the area served.

Security Systems

Campus security systems will be coordinated with the security system consultant. A raceway system will be provided for card readers, door switches, motion detectors, cameras, and similar security devices.

Power will be provided to security control panels and where required. Card access controlled doors will release and open upon activation of the fire alarm system.

Energy Efficiency / Sustainability

Energy conservation measures for consideration include the following.

Lighting

- Minimize incandescent lighting
- Fluorescent fixtures equipped with energy saving lamps and ballasts
- Zone or task lighting wherever energy efficiency can be improved by these measures
- Lighting levels based on IES standards
- 3500 kelvin for F32T8 lamp color
- In rooms where incandescent and fluorescent are provided for different uses, provide an interlock so that only one type can be used at one time

- Use LED type emergency exit signs with <7 watt and 5 yr warranty
- In enclosed stairwells, provide adequate daylighting if possible for emergency egress and put stairwell lighting on photocell control
- Maximize use of 3 and 4 lamp ballasts
- 15 minute twist timer for bulletin board lighting
- 4 hour twist timer for janitors closets

Ballasts

- 3 yr manufacturer's warranty
- UL listed class P and sound rated A
- Instant start and parallel wired, solid state, not hybrid
- Maintain light regulation of $\pm 10\%$ with $\pm 10\%$ input voltage variation
- Current total harmonic distortion <10%
- Flicker 15% or less with any lamp suitable for the ballast
- Designed to withstand line transients per IEEE 587, category A
- Meet FCC Rules and Regulations, Part 18
- Operate at 20 kHz or greater

Audiovisual (AV)

Audiovisual Systems Overview

Higher education teaching facilities require an ability to use multiple media technologies. Video projection, computer based training, video collaboration, remote management of technology, and immediate electronic transfer of information need to be integrated into the modern learning center. These technologies are important in teaching the next generation of students as well as valuable tools these students will use themselves in the future.

It is guaranteed that the available audio visual technologies will change during the course of the phased Master Plan implementation. Audiovisual options should be discussed at the beginning of each phase to determine the most appropriate technology and equipment for the phase.

Basic Instructional Media Treatment

Video and computer projection is a minimum need in all teaching labs, classrooms, and conference rooms. A video source, computer input panel, cabling, video projector and mount are included in the most basic level of equipment. Optionally, multi-media lecterns, instructor consoles, “smart” panels, and electronic white boards should also be considered in specific locations. The appropriate lighting, acoustics, and wiring and control become paramount to allow a flexible and easy to use system and will be carefully considered in the design.

Video Teleconference and Distance Learning

Video teleconference and distance learning contribute to an institution’s ability to collaborate with other institutions and researchers to reach beyond the confines of the campus. With the evolution of low cost cameras, video over category five cabling, and low cost transceivers, CCC can build a flexible infrastructure and route video into any of its spaces. The appropriate lighting, acoustics, and wiring and control become paramount to allow a flexible and easy to use system and will be carefully considered in the design.

Information Technology

Campus standards and available cost effective technologies are constantly changing. It is guaranteed that the available information technologies will change during the course of the phased Master Plan implementation. Telecommunications options should be discussed at the beginning of each phase to determine the most appropriate technology and equipment for the phase.

The following information technology description is based on general notions of what the campus will require in new buildings. These should be modified based on new technologies as they emerge.

- Cable lengths should not exceed 280’
- IDF rooms should be stacked and located for efficiency of distribution
- MDF and IDF rooms should be 10’x10’ minimum
- IDF cooling should be allowed 5,000 BTUs per rack, figure 4 racks per 10’ x 10’ room minimum

CAMPUS GUIDELINES, SYSTEMS AND STANDARDS

5.11. Acoustic and Noise Control

Goals

This is a design guide for controlling:

- noise and vibration generated by air-handling systems, plumbing systems, and mechanical/electrical equipment
- the transfer of noise between rooms
- the build up of sounds within rooms
- noise from mechanical systems impacting outdoor use spaces

These basic acoustical recommendations will be expanded in greater detail as the project develops.

The acoustical design shall follow the recommendations based on the Acoustical Society Of America's guide

"CLASSROOM ACOUSTICS -- A resource for creating learning environments with desirable listening conditions".

Background Noise Levels and Air Velocities for Ductwork

The air velocity should decrease at each duct branch from the fan discharge until the full velocity is reduced to that defined below. All ducts must be sized to account for the internal lining to meet these criteria. Do not place dampers directly behind the face of the terminal units; locate dampers a minimum of 10 feet upstream of diffusers. At 90 degree bends use airfoil turning vanes. Final duct branch air velocities must not exceed the following criteria by more than 100 fpm.

Recommended program noise criteria for the space types are as follows:

Noise Criteria	Space Type	Maximum Air Velocity at the Diffuser
NC 25	Distance Learning / Video Conferencing Auditoriums / Theatres (Any space with open microphones or seats more than 200 people)	325 fpm
NC 30	General Classrooms Conference Rooms	380 fpm
NC 35	Seminar Rooms Small Meeting Rooms Private Offices Libraries	450 fpm
NC 40	Open Plan Offices Cafeterias Laboratory Classrooms	600 fpm
NC 45	Hallways Restrooms and Other Public Spaces Laboratory Support Spaces	800 fpm
NC 45	Fume hoods noise levels at a distance of 5 feet from the sash, with sash open at operational height.	

Noise criteria are discussed in the 2003 ASHRAE Applications Handbook, Chapter 47, “Sound and Vibration Control”.

Mechanical and electrical equipment, including ducts and water pipes, must not directly contact the ceiling or walls of spaces with criteria of NC 25 or less. Ducts, pipes, and conduit must not pass through these spaces. Drinking fountains and toilets must also be located away from these spaces.

Air-Handling Systems

Locate AHUs above storage, equipment, or machine rooms; do not locate the AHUs above spaces having criteria of NC 30 or less. Use separate AHU Fan coil and fully ducted supply and return systems the video conference rooms and other spaces which require “after hours use” for meetings with other sites.

Air-handling units must be supported on springs incorporating neoprene pads (Figure 1). The isolators are to be selected on the basis of static and dynamic load including thrust and rotational inertia. Each isolator must be selected independently for the load distribution of the equipment. Specifications are to require isolation hardware selections to be submitted and reviewed.

Provide the following minimum clearances:

- 48 inches between the rotating equipment and spaces having NC 25 or less criteria
- 15 inches above ductwork for spring hangers
- 2 inches clear under vibration-isolated equipment

Fans

When centrifugal fans are to be specified, backward inclined (airfoil) or forward curve blades are preferred. When applicable, internal cabinet insulation should be specified. Allow enough room at the inlet and discharge for at least 5 equivalent duct dimensions of straight ducting. Inlets and discharges directly beneath the fan wheels are discouraged.

The mechanical specifications are to include an octave band maximum sound power level for each major piece of mechanical equipment.

Ducts

For spaces with noise criteria less than NC 30, use internally lined sheet metal ductwork to serve rooms from the corridor (i.e., locate all duct trunks over corridor and only branch into room being served). Exposed duct should not be considered in such spaces.

Supply Air Ductwork

Ductwork attached to the fan discharge should be connected with a flexible connector. Allow room for a 5-foot-long silencer near the fan. Allow for up to 2-inch-thick acoustical lining within 25 feet of the fan. Ductwork should have smooth transitions not exceeding 10 degrees. Use long radius elbows and straight ducts at the entry into all rooms. Avoid using bullhead tees. Turning vanes are to be the airfoil type. Spring-type vibration isolation hangers (Figure 2) are required for a minimum of 25 feet of lineal duct distance from the fan. From 25 to 50 feet, neoprene hangers (Figure 3) are to be used.

Return Air

Return air should be ducted from spaces with noise criteria less than NC 30. Allow for return air duct branches to be lined with a minimum of 1-inch-thick acoustical lining as required.

Spring-type vibration isolation hangers are required for a minimum of 20 feet of lineal duct distance from the fan. From 20 to 40 feet, neoprene hangers are to be used.

Variable Volume, Terminal Boxes, and Fan Coil Units

Terminal boxes are not permitted in or above spaces having a noise criterion less than NC30. The boxes serving spaces less than NC 30 should be located in adjacent corridor or storage area, and be ‘up-sized’ to minimize noise. Do not use fan-powered VAV boxes. All boxes require 10 feet of acoustically lined duct downstream prior to the diffuser.

CAMPUS GUIDELINES, SYSTEMS AND STANDARDS

5.11. Acoustic and Noise Control

Diffusers, Registers, and Grilles

Specify diffusers with an appropriate NC rating. Supply and return air outlets are required to meet the noise criteria. Diffuser test reports conforming to ARI Standard 880-1998 “Standard for Air Terminals” which contains octave band sound power levels, are to be submitted for spaces having NC 25 rating and less.

All ductwork serving spaces with noise criteria of NC 25 to 35, is to be lined for a minimum of 10 feet prior to the outlets. Dampers must be a minimum of 10 feet upstream of all outlets. Spaces with noise criteria of NC 25 and less require special consideration.

Plumbing Systems

Plumbing and rainwater leaders shall not be located within the ceiling or walls of spaces having a noise criterion of NC 25 or less. Regulate domestic water line pressure to 50 psig. Branch piping should have a maximum velocity of 6 ft./sec. Specify spring-loaded check-valves and water-hammer arresters.

Waste pipes are to be isolated using neoprene insulated clamps and resilient waffle pads under supports. Attach support only to one side of the double-wall framing. Cast iron waste pipe is recommended.

Sprinkler piping should be routed along corridors with a single penetration into each space.

Penetrations

Ducts penetrating the building structure should have a clear distance around their perimeter of 1 inch, +1/4 inch. This perimeter void must be packed with glass-fiber batts at both ends and caulked airtight with a non-shrinking, non-hardening, flexible acoustical sealant as shown in (Figure 4). A backer rod should be used to caulk again.

Piping penetrations less than 3 inches in diameter should be sealed as shown in (Figure 5). Larger pipes should be treated similar to ducts.

Piping Isolation

Vibration isolate all pipes except vents, gas, and sprinkler lines.

- A. Ridge metal-to-metal contact between pipes and their supports or the structure is not-permitted.
- B. Small pipes (less than 3 inches in diameter) require neoprene mount or hanger isolation for the first 25 feet from prime mover (i.e., Mason isolators ND or HD).
- C. Small pipes beyond 25 feet require resilient sleeves at the point of attachment (i.e., neoprene condensation insulation, or pre-formed glass-fiber pipe, (Figure 6), or insulated hangers similar to Semco Trisolator).
- D. Large pipes (3 inches in diameter and greater) require spring isolators with neoprene pads for the first 25 feet from a prime mover (i.e., Mason isolators SLR or 30 N).
- E. Large uninsulated pipes beyond 25 feet require neoprene mount or hanger isolation (i.e., Mason isolators ND or HD).
- F. Waste pipes and rainwater leaders are to be attached using neoprene mounts or resilient sleeves.
- G. Domestic water lines less than 1 inch in diameter can use proprietary resilient attachments such as the Tech. Specialties Acousto-Plumb or can be treated as small pipes beyond 25 feet (See “C” above).
- H. Use flexible piping to connect all vibration-isolated rotating equipment.

Electrical Equipment

Transformers, motors, inverters, and UPS systems should have their maximum sound level specified at one meter in situ. They should be remotely located from acoustically critical spaces and be vibration-isolated. Neoprene-in-shear mounts (i.e., Manson isolator ND or similar) should be used as vibration isolators.

Lighting dimmers should be remotely located in an enclosed room and vibration-isolated by means of neoprene-in-shear mounts.

Fluorescent or high-intensity lighting should not be used in spaces with NC 15 to NC 20 noise criteria unless ballasts are remotely located or are solid-state electronically controlled. Ballasts should be quiet, premium, or “A” sound-rated.

Rigid conduit must not bridge independent acoustic isolation walls. If bridging is necessary, flexible conduit is required. All mechanical and electrical equipment that is vibration-isolated should have flexible conduit connections (i.e., Sealtite).

Special detailing will be required for recessed fixtures, conduit, and electrical boxes in sensitive acoustical spaces

Sound Isolation

To control the transfer of noise between critical spaces the following walls should be full height acoustical walls.

Office party walls, walls around meeting rooms and other walls with a lower level of sound isolation requirements should be constructed similar to what is shown in detail W1.

Classroom walls with doors should be constructed similar to what is shown in detail W1; all other walls should be constructed in a manner similar to what is shown in detail W2.

Walls around acoustically critical spaces, mechanical rooms, distance learning rooms, should be double studded walls. The wall should be constructed similar to what is shown in detail W3.

Doors into classrooms, conference rooms, labs, and mechanical areas should be solid core acoustical doors with full perimeter gasketing.

Room Acoustics

To control the build up of sound within the classrooms, conference and meeting rooms, ceiling tiles should have a high NRC (Noise Reduction Coefficient) rating of 0.90 or higher.

To control the build up of sound within acoustically critical spaces such as distance learning rooms, gyms, auditoriums, etc. where speech communication is required, treatments should be made to follow the reverberation time guidelines as outlined by the ASA Classroom acoustics guidelines.

To reduce discrete echoes in rooms that are larger than 60 feet in depth, (front of room to back of room) the rear wall should be treated with a sound absorptive system with a high NRC (Noise Reduction Coefficient) rating of 0.90 or higher.

Exterior Noise Control

Continuous noise levels from exterior sources shall be controlled to the noise criteria rating level established for the space.

Transient noise levels are to be controlled to a level 10 NC points higher than that established for the space for no longer than 10 percent of the time, and to a level 5 NC points higher, for no longer than 33 percent of the time.

Fixed noise sources (roof top units, compressors, transformers, etc) are to be controlled to a noise level of NC 45 at exterior locations that are accessible to the public.

CAMPUS GUIDELINES, SYSTEMS AND STANDARDS

5.11. Acoustic and Noise Control

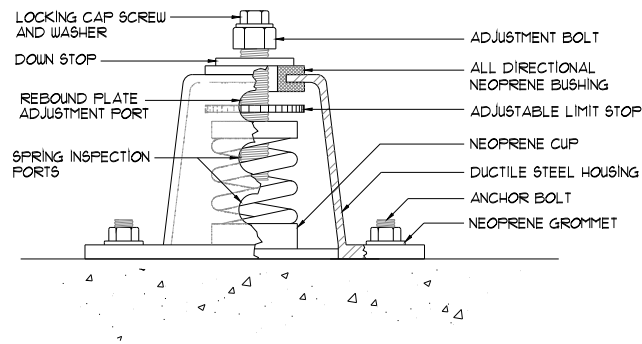

1 HOUSED SPRING MOUNT
 01093_1

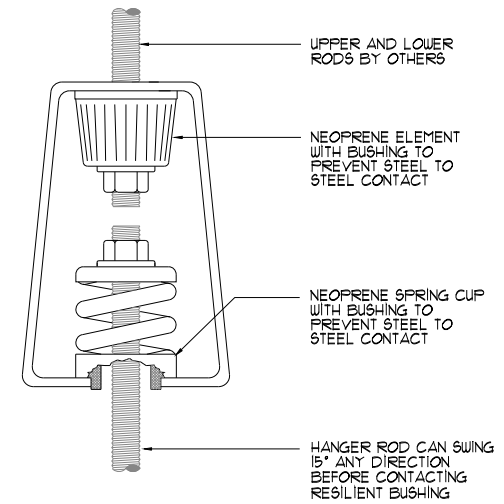

2 SPRING AND NEOPRENE COMBINATION HANGER
 01093_2

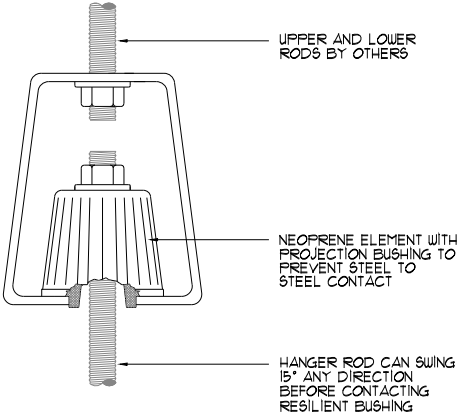

3 NEOPRENE HANGER

01093_3

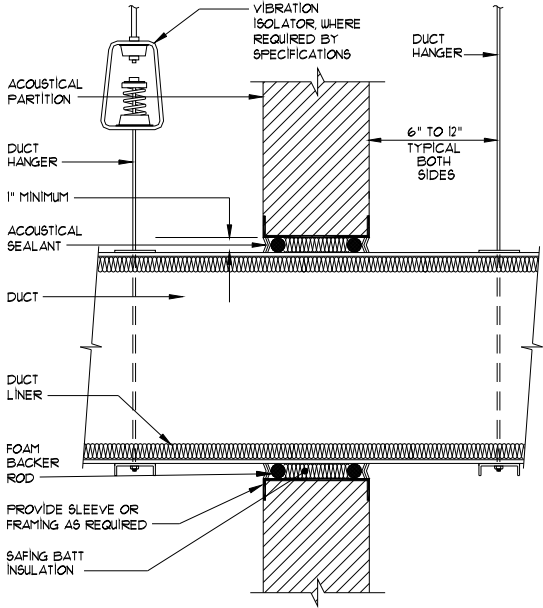

4 TYPICAL DUCT PENETRATION THROUGH ACOUSTICAL PARTITION

01093_4

CAMPUS GUIDELINES, SYSTEMS AND STANDARDS

5.11. Acoustic and Noise Control

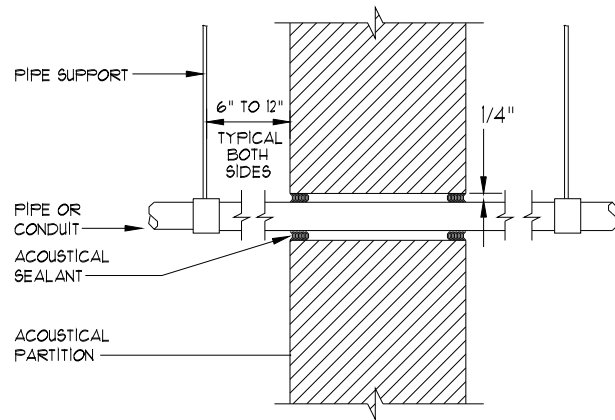

5 TYPICAL SMALL PIPE/CONDUIT PENETRATION THROUGH ACOUSTICAL PARTITION
(3" IN DIAMETER OR LESS)
01093_5

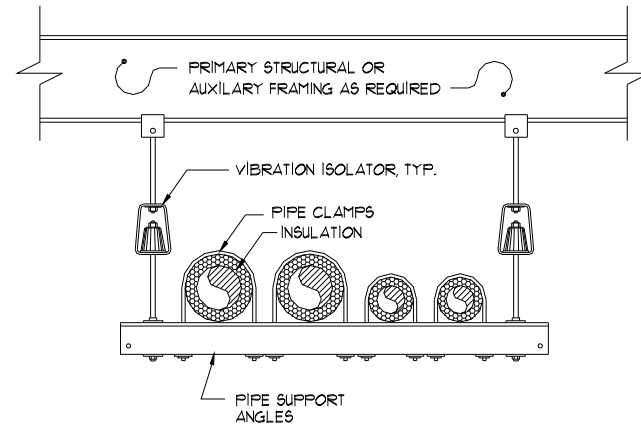

6 TRAPEZE PIPING SUPPORT
01093_6

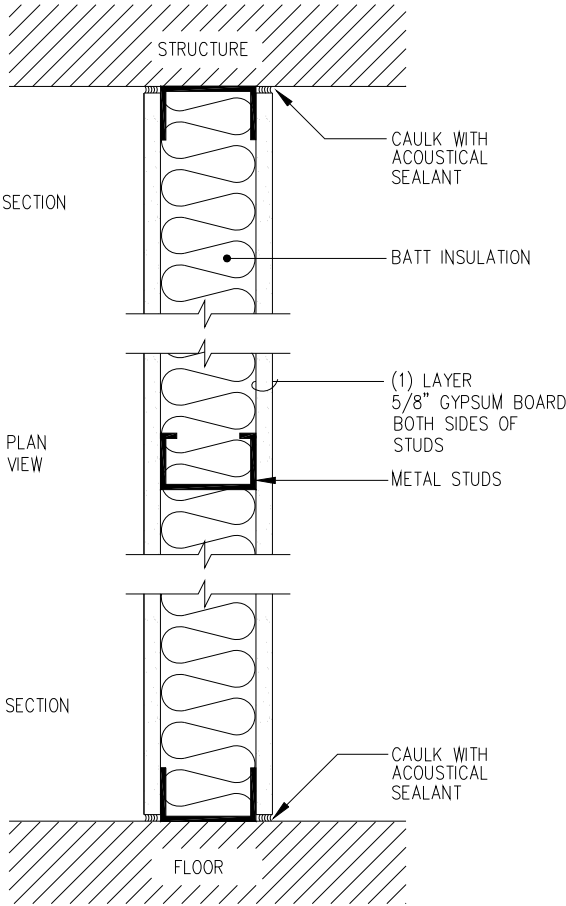

W1 STC 45 - ACOUSTICAL WALL

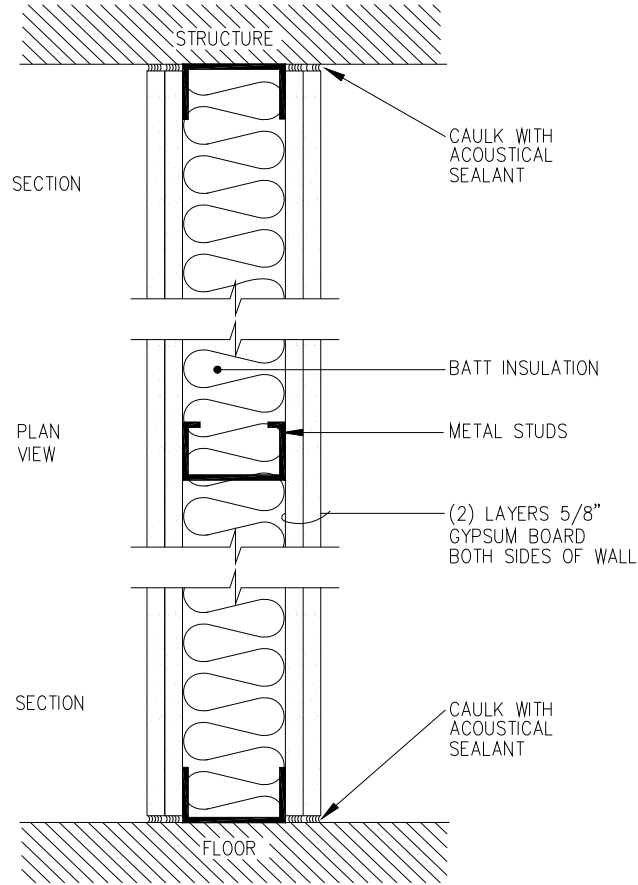

W2 STC 55 - ACOUSTICAL WALL

CAMPUS GUIDELINES, SYSTEMS AND STANDARDS

5.11. Acoustic and Noise Control

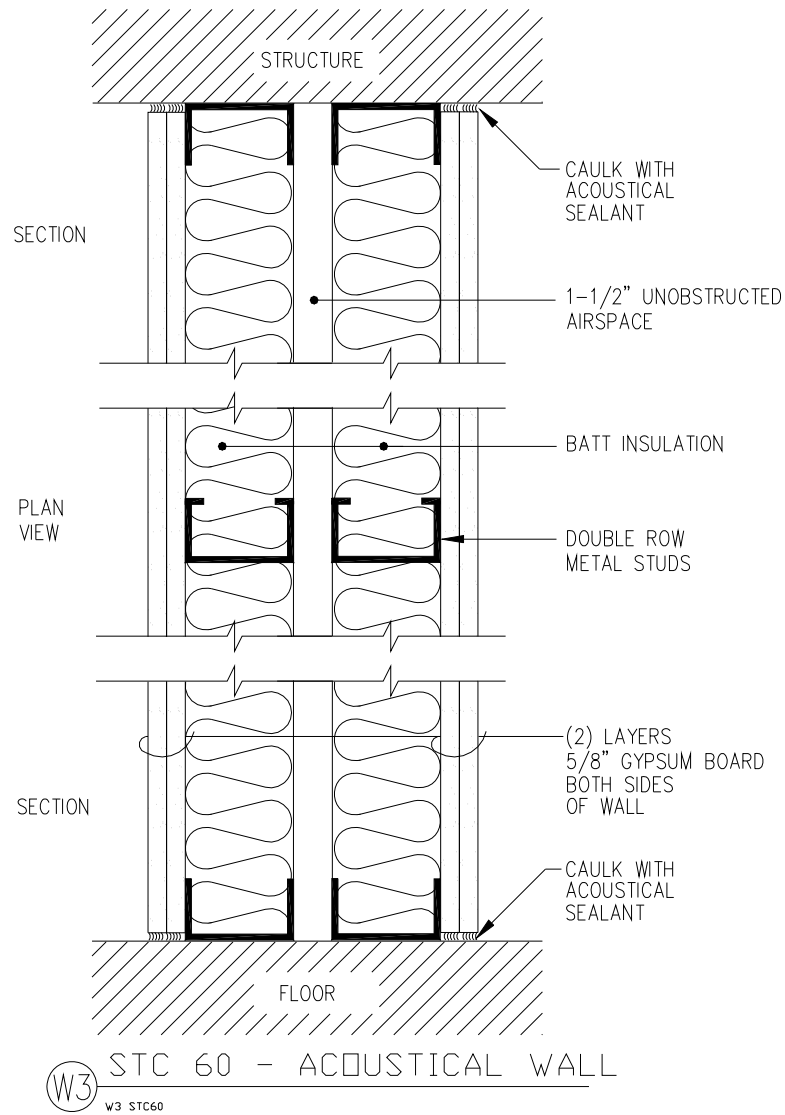

Sustainable Design Goals

Contra Costa College has identified sustainable design as an important and integral part of the design goals for the Campus Master Plan projects. As each phase of the Master Plan commence, the design team will evaluate and incorporate “green” measures into the building and site design as appropriate. The goals of reducing building and site impact on the environment and providing opportunities for students and other building users to learn about environmental issues and sustainable design technologies will remain paramount in the design process.

LEED™

The LEED™ rating system will be used to measure the sustainability of the project in each phase. LEED™ (Leadership in Energy and Environmental Design) is a self-assessing system designed for rating new and existing commercial, institutional, and high-rise residential buildings. It is a feature oriented system where credits are earned for satisfying each criterion. Different levels of green building certification are awarded based on the total credits earned.

Sustainable design as a topic is complex and large. LEED™ breaks it down, identifies key issues and corresponding design measures, and describes ways to quantify the results. Credit requirements are performance based rather than prescriptive, allowing the design team as much leeway as possible in developing specific design approaches. Standards used are based on code and industry standards.

Up to 69 points are available under LEED™. Evaluation at each project phase will determine what level of certification may be achievable. A minimum LEED™ level of Certified (26-32 points) will be targeted for each phase of the Master Plan.

It is important to note that LEED™ is only a standard for measuring sustainable design. It does not cover every topic, nor are the specific credits always appropriate or even applicable to a specific project. In addition, the specific requirements of a particular credit may be beyond the reach of the project, while the intent of the credit it still worth pursuit. Many of the points listed in the current project checklist may ultimately not be awarded, but will

nevertheless inform the design process. Similarly, there may be measures implemented that are not recognized or measured by LEED™, but are deemed worth pursuit by the project team.

A copy of the LEED™ for New Construction v2.2 Registered Project List showing possible credits can be found in the Appendix Section 6.8.

Site and Landscape Sustainability

The landscape guidelines as part of the Master Plan encourage a whole systems approach to the design, construction and maintenance of the campus landscape in order to support the integrity of the college’s local ecosystem - the San Francisco Bay watershed. Based on the Bay Friendly Stop Waste model developed by Alameda County, the key areas of sustainable site design include:

- Landscape in harmony with the local natural conditions.
- Reduce waste and recycle materials.
- Nurture healthy soils and reduce fertilizer use.
- Conserve water, energy and topsoil.
- Use integrated pest management to minimize chemical use.
- Reduce light pollution.
- Meet or exceed minimum standards for stormwater management.
- Preserve and restore habitat.

Many of these sustainability strategies, including stream restoration and landscape care, can and should be integrated with the College’s environmental education programs.

See Appendix Section 6.4 for the Bay Friendly Stop Waste Checklist developed by Alameda County.

CAMPUS GUIDELINES, SYSTEMS AND STANDARDS

5.13. Roadways and Drives Standards

General Requirements for Design and Construction

Efficient campus access requires a comprehensive and integrated circulation system. The plan must accommodate private and public vehicles, emergency vehicles, and pedestrian circulation to and from the campus facilities. In an effort to improve traffic and pedestrian flow, past inefficiencies need to be resolved by separating service access from main pedestrian paths of travel. Proposed traffic schemes and design guidelines presented in this Master Plan are at a schematic level, and represent a design intent which would need to be refined by a future design development effort.

Entry Drive and Pedestrian Drop-off

Currently, there is no well defined drop-off area that is easily accessible to both vehicles and pedestrians. The blocked extension of Castro Road is commonly used as a drop-off area, but is not designed to allow traffic flow or the safe loading and unloading of passengers. As well, this area is the main access for delivery and service vehicles.

A new entry drive is proposed connect Mission Bell Drive to Castro Road, allowing traffic from both directions to flow through a new drop-off area and pedestrian access from the main parking area to campus. This entry way will be 36' wide, with one lane in each direction. There will be no designated bike lanes, but access will be shared by both vehicles and bicycles. There will be no parallel parking on the entry drive. Public transportation will maintain the current drop-off area outside of the new entry on Mission Bell Drive.

The designated drop-off area will widen to two lanes in each direction with a center island. This area will have a mountable table spanning the full width of the drop-off roadway, which will provide traffic calming and allow for flush curbs for pedestrians that are crossing or loading and unloading.

Two-Way Loop Roadway

Currently, the campus loop road has one-way access traveling north from Mills Avenue to the Music Building parking lot, where it becomes a two-way road for the remainder. To improve campus access and traffic flow, it is desirable to improve the loop road to two-way access for its entirety. The current two-way portion of the roadway varies in width between 35' and 38'. There is parallel

parking on both sides and angled parking in some locations. In addition to maintaining this geometry, it is recommended that a 6' sidewalk be added to the campus side of the loop road.

The northeast portion of the loop road is restricted to one-way traffic currently due to the narrowing of the road at the southeast corner of the Applied Arts & Administration building. In this location, the roadway width narrows to 21' between the AA Building and the adjacent property line, and the existing roadway segment has a very steep grade of 19%.

Possible options for further study:

- Remove or relocate the existing equipment yard and retaining wall at the southeast corner of Building AA, allowing room for two 14' lanes of travel. This option could allow a less steep grade, but would change the layout of the parking area south of Building AA and would alter the intersection at Mills and the loop road, possibly affecting the ADA parking and drop-off area.
- Purchase an 8' wide section of the neighboring church property, allowing for two 14' lanes of travel. This option would preserve the parking and drop-off area, but may require prohibitively steep grades approaching the intersection from the north.
- Purchase property in the north side parking lot of the church, creating a new two-way entry to the campus from Shane Drive. The City may not be willing to approve a second campus entrance so close to the Mills entrance, and does not provide for a continuous loop road entirely on campus property.

Truck Access Ramp to Proposed Receiving

Plans to convert the existing Arts Building to Receiving will require truck access to the proposed loading dock at the west end of the building. Currently, there is a 150' asphalt paved ramp, 20' wide with a 10% grade descending from the parking lot to the west end of the Arts Building. The layout of this ramp, the paved receiving area adjacent to the building, and the orientation of the proposed dock area are such that the following truck movements are allowed:

- An SU-30 truck (single-unit with a 20' cargo area) can drive forward down the ramp, pull forward to the paving limits at the bottom and reverse into a loading dock. This truck can then pull forward up the ramp to exit.
- A WB-40 truck (semi-truck with 33' trailer) requires maneuvering to back down the ramp and into a specific loading dock area. Widening the ramp at the top will allow backing down the ramp with minimal maneuvering. Furthermore, the 28' wide driveway entrance to the parking lot requires that this size truck would need to back into the parking lot first before backing down the ramp. Backing into the parking lot entrance is possible if both lanes of the loop road are utilized.

The access ramp pavement appears to be distressed and the pavement condition should be evaluated to verify that it can sustain the required truck loading.

CAMPUS GUIDELINES, SYSTEMS AND STANDARDS

5.14. Parking Standards

General Requirements for Design and Construction

Parking will continue to be provided at-grade, as the use of parking structures is discouraged due to seismic constraints. Future parking locations shall be planned to utilize site areas where new building structures are not permitted due to the Alquist-Priolo zones.

Parking shall be provided as required by the City of Richmond and City of San Pablo Code.

Disabled parking stalls will be provide in the relative quantities and locations established by the ADA and Title 24.

Parking areas should provide a logical and safe circulation system for both vehicular and pedestrian traffic. Landscape elements should be used to help diminish the scale of paved areas, provide shade, and screen parking at perimeters. Development Standards for Parking include the following:

- Parking will not be permitted on the Entry Drive, but will be permitted on the Perimeter Loop Roadway as if feasible.
- Unistall dimensions (18' x 9') are used in lieu of standard and compact dimensions. If unistall spaces are used, all spaces (except accessible stalls) must be unistall. (Alternately, Standard parking stall is 19' x 9', and a Compact stall is 16' x 8'.)
- All parking areas adjacent to the Road shall have a minimum 10' landscaped setback.
- Lay out parking in cohesive units related to specific buildings.
- Adjacent parcels may share circulation and access where possible.
- Planting design within parking lot perimeters should be compatible with adjacent landscape and open areas.
- Minimize single row parking; maximize parking in blocks and multiple rows.
- Incorporate pedestrian medians for safe pedestrian access to building entries.
- Avoid parking along building frontages.
- Where layout exceeds two rows in depth, align rows in direction of pedestrian movement whenever possible.
- Overhang into adjacent landscape areas should be 2 feet for standard and unistall space, 1-½ feet for compact spaces. Overhangs are encouraged to reduce the overall pavement area.
- Landscape elements such as earth berms planted with shrubs and columnar trees should be used to screen views to the designated parking areas.
- Finish pavement grade at the perimeter should be at or below the street top of curb elevation adjacent to the parking.

General Requirements for Design and Construction

The goals of grading and drainage for the site are to preserve, where possible, the existing topographic conditions, to prevent any damage or disruption from flooding or erosion, and to incorporate sustainable solutions to treating and retaining runoff as much as practicable. Where possible, building placement should take advantage of the existing conditions and not seek to significantly alter the natural topography. Development Standards for Grading and Drainage include:

- New impervious areas (parking areas, building roofs) should be drained to vegetated bioswales in landscaped areas to allow natural infiltration or filtering before discharge into the storm drainage system.
- No areas should discharge onto adjacent properties or public roadways.
- All landscape areas should be graded to drain away from buildings at 2% minimum slope.
- City and County flood control should be consulted regarding current NPDES C.3 requirements that may apply to site improvements.
- An erosion control plan must be submitted for proposed construction areas.

CAMPUS GUIDELINES, SYSTEMS AND STANDARDS

5.16. Planting Areas Standards

Development Guidelines for Planting : Sustainable Landscape Practices

- Use local plant communities as models and plant California natives or Mediterranean plants.
- Choose plant species specific to the campus microclimates and soil types.
- Choose plants that can grow to their natural size in the space allotted.
- Reduce shearing.
- Do not plant invasive species.
- Minimize lawn area.
- Use recommended plant materials listed in Appendix 6.5.
- Create drought resistant soils with compost and mulch.
- Protect soil from compaction.
- Repeat landscape elements to provide visual cohesion.
- Screen undesired views, such as parking areas, service, site equipment and refuse collection areas.
- Establish a tree canopy for parking lots.
- Use tree canopies and plantings to shade buildings.

Maintenance Guidelines

- Amend the soil with compost before planting
- Keep plant debris on site
- Recycle grass clippings

- Produce mulch and compost from plant debris
- Mulch regularly - Mulching conserves water, enhances the growth of plants and the appearance of the landscape. It can also simplify your operations-therby lowering your costs-by suppressing annual weed growth and reducing the need for trimming around trees and poles.
- Feed soils naturally and avoid synthetic fertilizers.
- Minimize the use of chemical pesticides.
- Use Integrated Pest Management

Area Specific Guidelines

Existing landscape conditions and proposed Master Plan improvements suggest a series of distinct landscape areas and types characterized by use, experience, and maintenance requirements. Each type is described in Section 4.7 - Site Landscape Areas and various types require specific planting area guidelines.

Development Standards for Planting

Campus planting area minimum plant sizes:

Trees	24" box minimum
Shrubs	5 gallon minimum
Groundcovers	5 gallon minimum
Ornamental Grasses	5 gallon minimum
Vines	5 gallon minimum

Stream and Habitat Restoration areas minimum plant sizes:

Trees	Treebands
Shrubs/Perennials	Deep pots

Maintain the following minimum widths for sidewalks and planting areas adjacent to buildings:

Building Front- 20' average/ 10' minimum width.

Building Side and Rear- 15' average/ 10' minimum width.

CAMPUS GUIDELINES, SYSTEMS AND STANDARDS

5.17. Irrigation Standards

Development Guidelines for Irrigation

- The irrigation system will be designed with water conservation in mind.
- Implement hydrozoning-group plants by water needs.
- Different plants have different water requirements. Dividing the landscape into low, medium and high water use zones prevents over-watering. Irrigation can then be more easily matched to the plant requirements. This fosters resistance to pests, reduces plant mortality and conserves water.
- Minimize lawn area.
- Turf requires frequent watering to stay green during the long dry season. Minimizing lawn size can conserve water.
- Plan for on-site rainwater collection, recycled water and/or greywater use.
- Manage and maintain the irrigation system to reduce wasted water.

Development Standards for Irrigation

- All planted areas should be automatically irrigated.
- East Perimeter Landscape and Stream Corridor Restoration Area to be temporarily irrigated for establishment only.
- All irrigation details and specifications should, as a minimum, conform to Contra Costa College design standards.
- The landscape will be provided with water by means of spray irrigation to the turf areas and groundcover areas, gear driven rotors for more expansive turf and groundcover areas, drip irrigation for the large shrub mass areas, and bubblers to the tree.
- The spray system will be designed using spray heads with pressure compensating nozzles to achieve an even level of precipitation throughout the irrigation system. A state of the art irrigation controller will be specified for this project to control the water allocated to each valve grouped per individual hydrozone (based on plant type and exposure). This may include the incorporation of a master valve flow sensor combination, rain sensor and possibly an on-site weather station that features an anemometer for wind-speed measurements, a rain gauge to measure rain fall and ET tracking capabilities for precise evapotranspiration calculations to develop accurate system run times minimizing waste of water resource.

Materials

Meter: Separate irrigation meter or well system with metered back-up

Controller: Master Control System - Rainmaster Controller

Data line to controller

Surge protection

On-Off switch

Exterior GFI outlet

Controller Enclosure: Strong Box SB-16SS

Stainless steel, top mount

Positioned to face field or irrigated area as possible

Backflow Preventer: Febco

Ball valves each side

With or without pressure regulator as required

In line strainer with clean out at each system

Enclosure: BF-168 Dual swing enclosure keyed with District ES203 lock

Green expanded metal on 6" concrete pad

Master Control Valve with flow meter and by pass

Griswold, always open

Rainmaster flow meter

Control wire: #14UF, white wire for common

Booster Pump

Rainbird package system, Flowboy or Watertronics

Gate Valve

Nibco P-619 RW push on gate valve or

watts-supply valve key to shut off valves

Irrigation Control Valves- Buckner 2000

Griswold with PVC ball valve upstream

Buried 6" deep with 8" x 8", 1/4" thick galvanized metal plate bolted to lid

Y-strainer as required

Carson or Brooks valve box

Quick Coupler

Rainbird 44NP

One per valve grouping, every 200' minimum

Install on 18" Dura swing joint

Install in 9" round Brooks or Carson valve box

Irrigation Heads

Hunter

Rainbird 700S pop-ups

6" pop-up in turf, 12" pop-up in shrub beds on Dura swing joints

Sleeves to be double the mainline or lateral line size

Specify contractor supplied extra parts

1 head for every 10 installed

1 swing joint for every 10 installed

1 valve per size

Pressure Test: District to be present for mainline pressure test

Pipe & Pipe Fitting Wiring: Per District Standards

Main line-PVC 18" depth min in 6" of sand

Schedule 80 with schedule 80 fittings, with tracer wire and locator tape over lines, end wire terminating @ valve boxes

CAMPUS GUIDELINES, SYSTEMS AND STANDARDS

5.18. Outdoor Use Areas Standards

Development Guidelines for Outdoor Use Areas

The campus plan and building configuration present numerous opportunities for plazas, entry courts and connecting paths. These will reinforce building entry locations, create outdoor use areas and establish connections for vehicle drop-off and parking areas.

Entry courts encourage the extension of the landscaping up to, and even into, buildings. They combine with architectural entry features to create rich transition zones between the outdoor and indoor environments.

These areas provide garden-like settings for social interaction. Special paving, planting, and site furnishings that are attractive, durable, and consistent are described in subsequent sections.

Plazas and Courtyard Guidelines

- Pedestrian use areas should be provided at building entries and/or adjacent to buildings. Entry courts that engage projecting entry features or entry features which extend into the building mass are encouraged to create transition zones between public and private spaces.
- Planters, low walls, and signs should enhance the sense of transition between the public and private realm.
- Feature paving materials, planting, and site furniture should be provided at entries and outdoor use areas.
- Entry courts should provide space for bicycle parking racks and seating areas for students.

Campus Quad and Amphitheater Guidelines

- The amphitheater will be a combination of paved and lawn terraces.

Walkway Guidelines

- The paving materials standards relate to the Site Landscape Areas and Types Diagram. Walkways in Area F are to be concrete. Walkways in Areas E and G are to be asphalt or stabilized crushed stone depending on site conditions such as slope or route of accessible path of travel.
- The campus offers the potential for varied pedestrian experiences. The reconfigured parking areas reinforce the pedestrian connections to the central campus. Paths through the new campus center connect Central Campus to the Upper Campus and span the North Tributary of Rheem Creek.
- Pedestrian links should be provided between open space areas and the building entries.
- Walkway paving in the academic central campus will consist of minimum 6'-0" wide concrete.
- Service walks may be constructed of concrete, asphalt, or stabilized crushed stone.
- Maximum walkway slope is 5%.

Paving Materials Standards

New construction of plazas and walkways will use these material standards. Future improvement or repair of existing pathways and plazas over time will follow these standards. The intention is to create a compatible palette implemented at the discretion of the designer.

Concrete Walkways

Integral colored concrete

- Davis: Mesa Buff
- Light broom finish and sawcut joints.



Plaza or Special Area Paving

3 paving materials have been selected for plaza areas.

Field areas: Concrete Unit Pavers

Edges, Band and Inlay Areas: Integral colored concrete or Brick Pavers

Integral colored concrete

- Davis: Mesa Buff
- Sandblast finish and sawcut joints.

Concrete Unit Pavers

- Stepstone
- Almond 506, Sandblast finish
- Porcelain 513



Brick Pavers

- McNear Brick & Block
- Color: McNear Red
- Installation: Sand set



Asphalt Walkways

6'-0" wide minimum with wood headers each side



Stabilized crushed stone areas

Decomposed granite or crushed granite aggregate

- Lyngso Garden Materials: Gold Dust ¼" Minus or Grey



CAMPUS GUIDELINES, SYSTEMS AND STANDARDS

5.19. Site Furniture Standards

Development Guidelines for Site Furniture Standards

The addition of ample site furnishings to all major and connective open space will contribute greatly to the transformation of the entire campus into an inviting and stimulating environment for people. Benches, tables, chairs, and trash receptacles should be located to enhance the open space experience by providing a variety of places for outdoor eating and gathering.

- Site furniture guidelines establish visual continuity and high-quality standards for these elements.
- Selection, design and siting of the site furnishings should depend upon their function and aesthetic contribution to their surroundings.
- Seating should be an appropriate scale and design to contribute to the comfort of the campus environment.
- Site furnishing designs should be integrated with other site elements (i.e. walls, lighting, signage, etc.).
- The color, texture, form, material and detailing of furnishings should reinforce the design of each area as well as those of the campus as a whole.
- Furnishings should be designed or selected for safety, durability, and ease of maintenance and replacement.

Areas of new construction will use these site furnishing standards. Future improvements and replacement of existing furnishings will follow these standards.

Bench

Landscape Forms Plainway Bench

Bronze Powdercoat

Surface mounted



Trash and Recycling Receptacles

Provide 1 trash and 1 recycling at each location.

Landscape Forms Plainway Trash Receptacle

35 gallon

Bronze Powdercoat

Freestanding

Location: Central and Upper Campus



Wabash Valley Trash Receptacle

55 gallon

Bronze Powdercoat

Freestanding

Location: Campus perimeter, parking areas and athletic fields



CAMPUS GUIDELINES, SYSTEMS AND STANDARDS

5.19. Site Furniture Standards

Movable Picnic Table

Landscape Forms Gretchen Picnic Table

ADA Wheelchair Accessible

Exterior Redwood, Bronze Powdercoat

Freestanding



Fixed Picnic Table

Columbia Cascade Timberform Parkway

2162-6 and 2163-6 ADA WC Accessible

Kiln dried Douglas Fir, Bronze Powdercoat

Imbed mounting

Optional 2095 gameboard



Game Table

Columbia Cascade Timberform Parkway

2054 Table and Seats

Kiln dried Douglas Fir, Bronze Powdercoat

Imbed mounting

Optional 2095 gameboard



Tree Grate

Ironsmith Market Street Tree Grate

Cast iron, 6 feet square with 12" opening

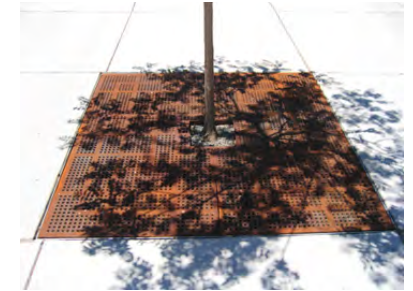

Memorials

Memorials may be established through the Contra Costa College Foundation and are to be associated with one of the following types of site fixtures.

Brass Plaques at Tree Grates

Brass Plaques on Bricks

Engraved Bricks

Benches



CAMPUS GUIDELINES, SYSTEMS AND STANDARDS

5.20. Service Area Standards

Dedicated service and utility areas are necessary for effective building operations. Loading docks, service yards and associated areas will be screened from view of surrounding residential areas, streets, the loop road and campus entry drives. These areas shall be located either inside closed buildings or behind a visual barrier.

All backflow prevention devices will be painted and screened from view. Screens shall consist of berms, walls, or plantings integrated into the landscape plan. Landscape screens shall include shrubbery selected by species and planting density to establish a complete screen within one year from the date of planting.

Loading Docks

- Loading dock areas will be set back, recessed, and screened from view by walls, berms, or plantings.
- All screen enclosures will be designed as an integrated part of the building, constructed of durable materials with finishes and colors and compatible with the overall architectural character.
- Where possible, services and utilities should share the same enclosure.
- Transformers and other utility equipment located above ground shall be screened with planting, berms, or enclosures. Exterior mounted utility equipment should blend with its surroundings.
- Exterior on-site utilities (including drainage systems, sewers, gas lines, water lines, electrical, telephone, and communications wires and equipment) must be installed underground except, where required to be above ground by government agencies and/or utility companies.

Refuse Collection Areas

Access to trash and recycling areas will be provided for all buildings. Each of these areas will be properly screened from view of surrounding residential areas, streets, the loop road and project entry drives. Trash and recycling collection areas shall be located either inside closed buildings, behind a visual barrier at the loading docks, or in dedicated, enclosed site structures. Specific location requirements will be confirmed with those companies providing collection services.

- Centralized trash and recycling collection will be accommodated in the Maintenance Yard. All containers will be completely screened from view as described below.
- Secondary trash and recycling enclosure areas should be located for convenient deposit and collection of refuse. These should be screened from view of adjacent properties and streets.
- Where external from buildings, refuse collection areas should be fully screened from view by walls, berms, or plantings.
- All screening enclosures should be constructed of durable materials with finishes and colors that are compatible with the project's overall architectural character. Enclosure walls should be planted with vines to soften their appearance.
- Where possible, trash and recycling enclosures may share the same enclosure with site utilities.

Development Guidelines for Walls and Fences

These elements are intended to retain earth, to screen some service activities and provide security. Site walls define outdoor use areas, relate to building shapes and materials, and reinforce the distinctive, consistent identity of the project.

- All fences and walls should be in accord with the project’s site and architectural character.
- High walls are discouraged- Fences should not be higher than 6 feet.
- Service Area walls will generally be complimentary to building exterior walls.
- Fencing and high walls between buildings is discouraged.
- Chain link fence is discouraged except where required for temporary barriers or at perimeter areas. When allowed, it will be dark color vinyl and planted with shrubs and/or vines.
- Decorative walls, seat-walls and retaining walls will be cast in place concrete.

Outdoor use area / plaza seatwalls

Cast in place concrete with anti skateboarding devices.

24” wide and 18” high

Natural colored concrete with Davis Color: Cobblestone



Skatestopper

Grind To a Halt GrinderMinder
Skatestoppers at 3’-0” on center



Site retaining wall

Cast in place concrete

Natural colored concrete with Davis Color: Cobblestone



Service area walls or enclosures

Cast in place concrete or simple concrete masonry to match building exterior walls.



Public frontage and perimeter fence

Ameristar Fence Products Aegis 2
Ornamental Metal Fence

Cane top at back perimeter

Flat top at public frontage

Bronze polyester powder coating



Chain link fence

Dark bronze, vinyl coated

Standard mesh, 1” mesh and mesh with slats to match vinyl coating



CAMPUS GUIDELINES, SYSTEMS AND STANDARDS

5.22. Site Utilities Standards

General Requirements for Design and Construction

Campus Standards for on-site utilities should be coordinated with and conform to the standards and requirements of the utility system to which they are connected. Following is general criteria and points of contact for the utility agencies that serve Contra Costa College:

- **Water:** East Bay Municipal Utility District (EBMUD) provides water service to the campus. All water facilities past the meter belong to Contra Costa College. EBMUD requires specific backflow prevention devices and connection fees for all points of connection to their system. Contact: Mark Swearingen, (510) 287-1278.

Fire service is provided by EBMUD, but is regulated by the Contra Costa Fire Prevention District as to building access, fire water structures, and pressure and flow criteria. All improvement plans should be approved by CCFPD. Contact: Fire Marshall Richard Carpenter, (925) 941-3520.

- **Sanitary Sewer:** West County Wastewater District (WCWD) owns, operates and maintains the sanitary sewer mains that traverse the campus. WCWD should be contacted and coordinated with prior to all improvements that are within their easement or connect to their lines. All sewer laterals are owned and maintained by Contra Costa College. Contact: Paul Winnicki, (510) 222-6700.
- **Storm Drainage and Stormwater Management:** All storm drainage structures and lines on campus are owned and maintained by Contra Costa College. Current regulations place very stringent requirements on sites discharging stormwater to the public storm drainage system. All proposed improvements need to be reviewed for NPDES C.3 compliance, as current management requirements can greatly impact a project's viability. Contact: Adele Ho, Director of Public Works, City of San Pablo, (510) 215-3068.
- **Gas:** All natural gas structures and mains on campus are owned, operated and maintained by PG&E. PG&E should be contacted and coordinated with prior to all improvements that affect their gas facilities on campus.
- **Electric:** PG&E serves electric power to the campus, but all electric facilities on campus are owned, operated, and maintained by Contra Costa College.

Site Utilities

Aesthetic Requirements for Design and Construction

Development Standards for Utilities are intended to prevent or minimize the visual presence of overhead, above ground utility and communication equipment. Guidelines include:

- Exterior on-site utilities including drainage systems, sewers, gas lines, water lines, electrical, telephone, and communications wires and equipment should be installed underground.
- On-site utilities should be designed and installed so that they are compatible with landscaping, paving, maintenance, construction activities or with other utilities

Development guidelines for exterior signage

- Create a distinctive visual identity that embodies the character of Contra Costa College with signage that will be appealing to a wide audience for a 30-year duration.
- Improve wayfinding for both vehicular and pedestrian circulation by enhancing the ease with which users move through the campus, building on users’ existing knowledge of wayfinding, and strategically anticipating users’ need for information.
- Create a comprehensive signage system that is consistent, yet adaptable to changes over time, and that is low-maintenance with readily available parts.

Standardized elements

- Sign Manufacturer
- Color Palettes
- Proportion
- Font
- Icons
- Sign Types

See Appendix Section 6.6 for complete signage standards.

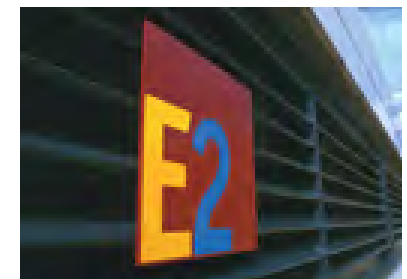

CAMPUS GUIDELINES, SYSTEMS AND STANDARDS

5.24. Exterior Lighting Standards

General Exterior Lighting Description

In addition to providing an atmosphere of greater safety and accessibility, exterior campus lighting is the most dominant visual feature of the campus at night. The quality and intensity of light, as well as the rhythm and pattern created by placement of fixtures, will contribute to the overall aesthetic character and sense of unity of the campus. In daylight the appearance of the fixtures themselves will also impact the campus character, though to a lesser degree.

The lighting standards intent is to meet aesthetic goals, address LEED standards, meet municipal requirements and to provide a safe environment for pedestrians and vehicles.

Uplighting on building facades can also contribute to safety by providing some general reflected and spill lighting. Lighting at building entries should glow brightly as easily identifiable destinations.

Roadways and Parking Areas

- High pressure lamps provide general illumination from thirty foot high light standards.
- Service, parking areas and major vehicular ways should be lit to a minimum of 2 footcandles.

Pedestrian light – Plazas and pathways

- Major pedestrian routes, including all routes from parking areas to buildings, are to be lit to a minimum of 1 footcandle, with additional security provided by special lighting such as wall lights.
- Secondary pedestrian routes are to be lit to a minimum of .5 footcandles.

High Mast Light - Plazas

Adjustable ball lights, mounted in cluster on high poles, are to be used to light large open areas of high pedestrian use where an open area unobstructed by multiple poles is desirable. The poles extend high above eye-level, and the tops of trees, and are thus less noticeable during the day. Each pole can hold several directional fixtures which can be aimed as needed to create an even level of light across a wide area, rather than limiting the light to just the pathways, in order to make the entire area usable and safe.

New Entry Roads

Gardco Lighting Gullwing G13



Parking Areas

Reuse existing cobra lights in parking areas



Pedestrian Light

Louis Poulsen Kipp Pole Light

Match existing color

Fixture: KIP-1/150/CMH-T-6 G12-208-TDRA-5"-3"-Black

Pole: DRA-5"-3"-12'-Black

Mount top of fixture at 14' above finish grade



High Mast Light

Sistemalux Maxiwoody



Wall Light

FC Lighting FSCL 400 Series



Step Light

FC Lighting FSCL 110-310

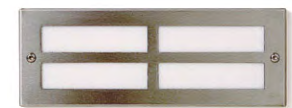

APPENDIX

6.1. Options Reviewed : Presentation 03-29-2007

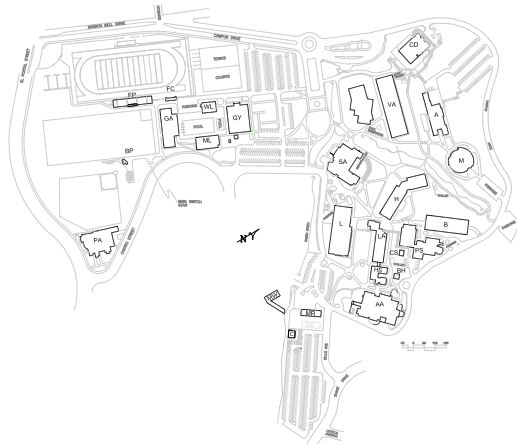

6.1. Options Reviewed : Presentation 04-09-2007

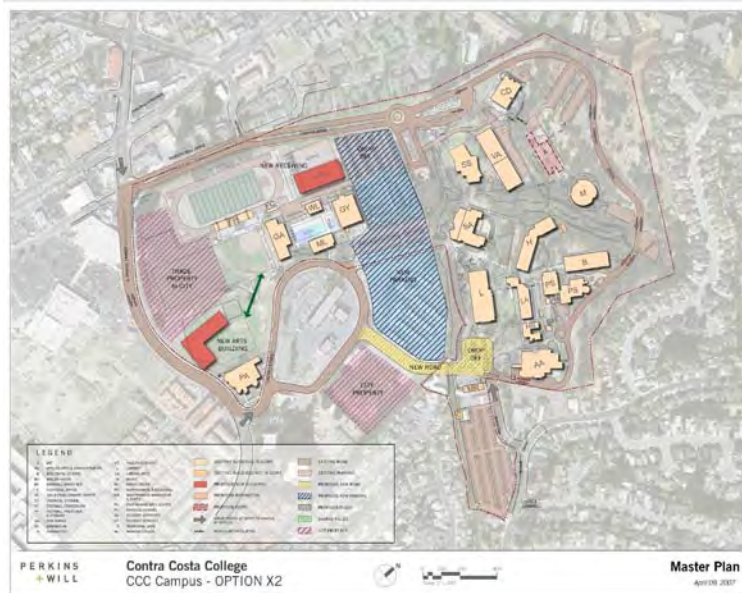
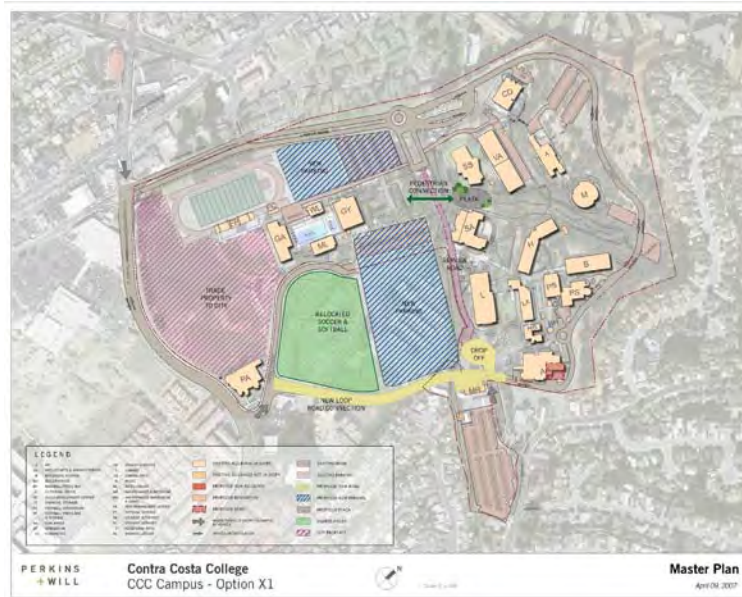

APPENDIX

6.1. Options Reviewed : Presentation 04-13-2007

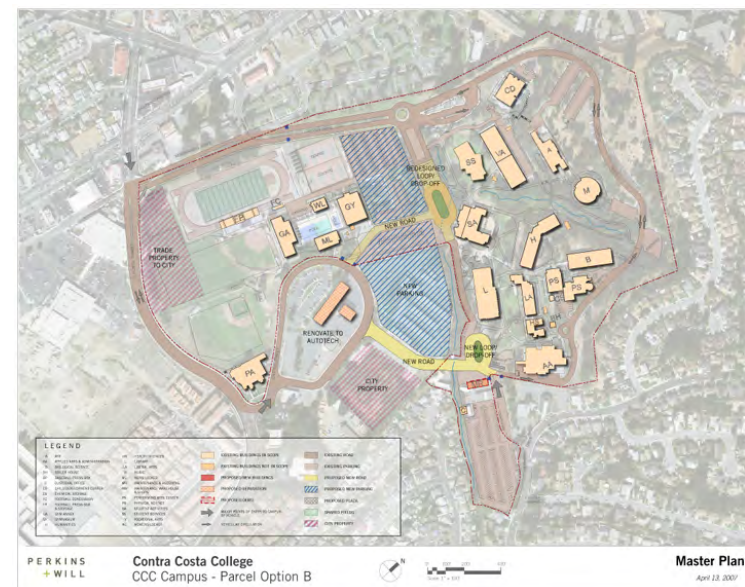
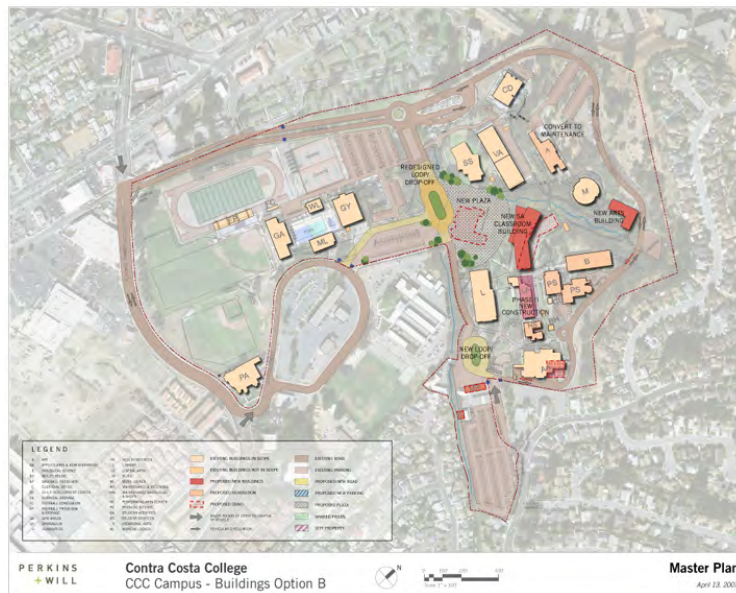

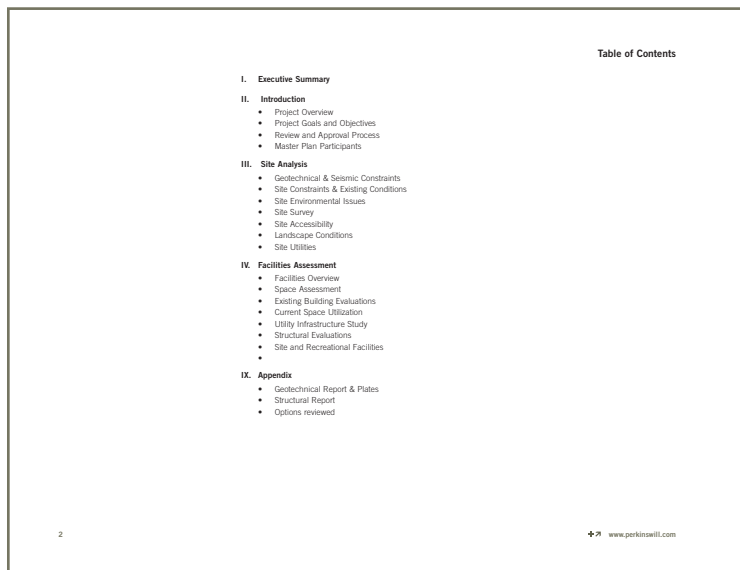
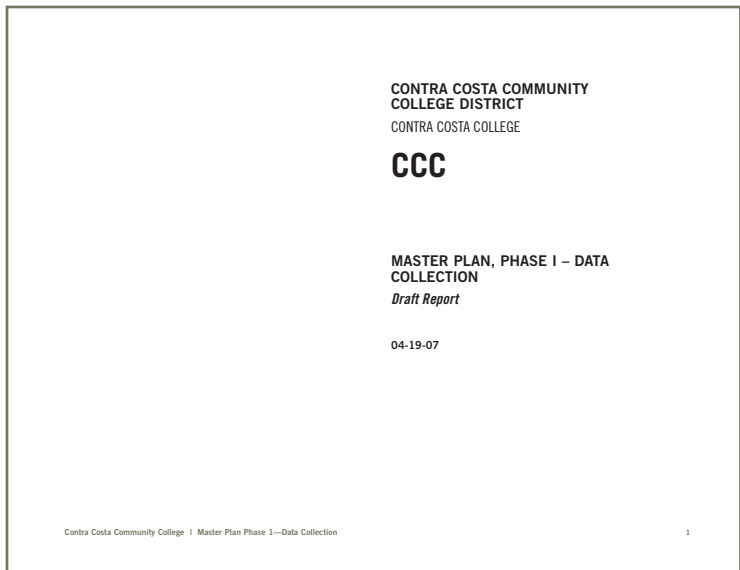

APPENDIX

6.1. Options Reviewed : Presentation 04-19-2007

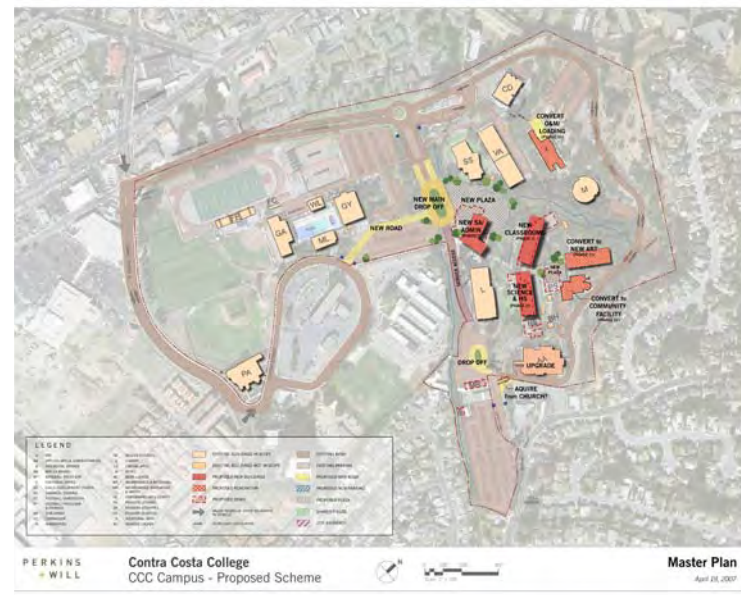
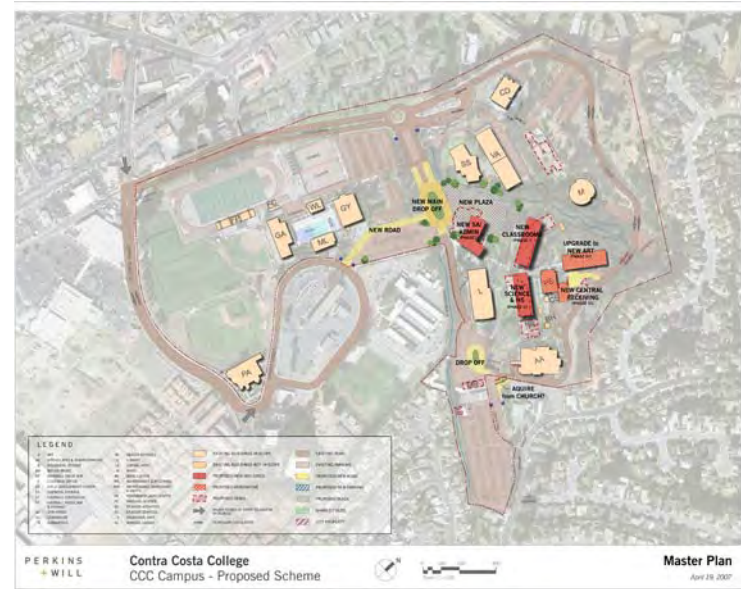
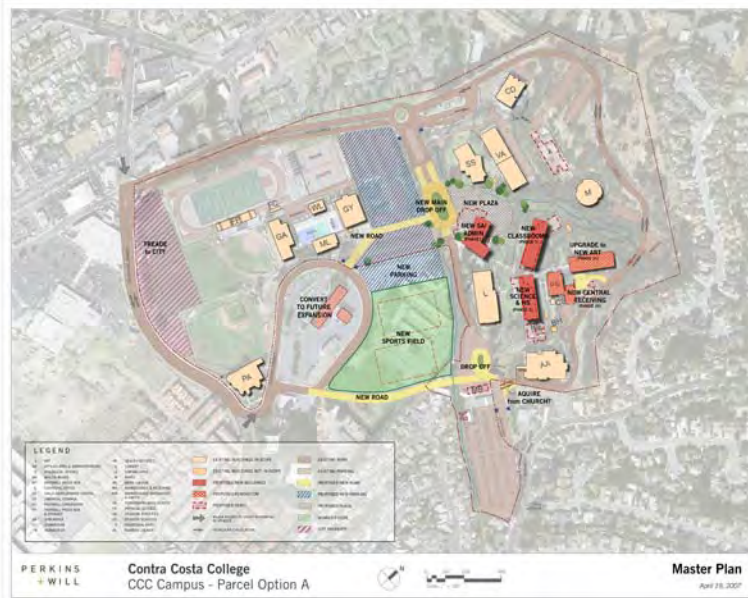



APPENDIX

6.2. Meeting Minutes

185 Berry St., Suite 5100 t: 415.856.3000
 San Francisco, CA 94107 f: 415.856.3001
www.perkinswill.com

185 Berry St., Suite 5100 t: 415.856.3000
 San Francisco, CA 94107 f: 415.856.3001
www.perkinswill.com

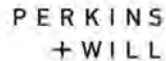

Meeting Minutes

To:	File 3.03	Date:	04/03/2007
From:	Karen Cribbins-Kuklin	Project Name:	CCC Data Collection & Master Plan
Date of Meeting:	03/29/07	Project No:	496022
Location:	CCC Campus	Subject:	CCC Charette - Meeting No. 5

Attendees:		
Name	Company	Email address
✓ McKinley Williams (MW)	CCC	mwilliams@contracosta.edu
✓ Carol Maga (CM)	CCC	cmaga@contracosta.edu
✓ Teresa Greenwell (TG)	CCC	tgreenwell@4cd.net
✓ Bruce King	CCC	bking@contracosta.edu
✓ Terence Elliott	CCC	telliott@contracosta.edu
✓ Mariles Magalong	CCC	mmagalong@contracosta.edu
✓ Mercy Pono	CCC	mpono@contracosta.edu
✓ Kindred Murillo	CCC	kmurillo@4cd.net
✓ Mario Rebholz	Parsons Brinkerhoff	rebholz@pbworld.com
✓ Bruce Rich (BR)	Parsons Brinkerhoff	richb@pbworld.com
✓ Karen Cribbins-Kuklin (KCK)	P+W	Karen.Kuklin@perkinswill.com
✓ Stacie Velten (SV)	P+W	Stacie.Velten@perkinswill.com
✓ Dawn Kang (DK)	P+W	Dawn.kang@perkinswill.com
✓ Susan Seastone	P+W	Susan.seastone@perkinswill.com
✓ Hyuek Rhee	P+W	Hyuek.rhee@perkinswill.com
✓ Nick Seierup	P+W	Nick.seierup@perkinswill.com



Item #	Item	Resp.	Due
1.0	Vision & Goals		
	<ul style="list-style-type: none"> Integrate Middle College Students with campus – not segregated. Provide Middle College Students & Faculty space for a study hall. Isolate M.C. space in CAP Load report to state; higher usage ratio. Improve ADA access. Improve traffic circulation around campus. Improve pedestrian circulation. Center in north service area – Hercules Crockett Rodeo (lose students to DVC) (new housing). Non-credit classes offered in H.S. after hours to attract students. Transfer courses in North region. Improve campus image to attract students. Critical that every classroom wired for tech. & have smart classrooms. Buildings need improvement. Landscape well established/mature Lack of cafeteria, recreation room, lack of (N) appealing bldgs., but want to attract students. Good programs in good facilities. Need mtg. place for community (100-150 people). Fireside room. Hi-tech. Gym in poor condition. Social space properly located. Recruitment – bring jr. high & H.S. students – need a place to “showcase” campus to them. SA fireside room being used for temp. surge space. Small rooms only available for mtgs – need more mtg 		

185 Berry St., Suite 5100 t: 415.856.3000
 San Francisco, CA 94107 f: 415.856.3001
 www.perkinswill.com

185 Berry St., Suite 5100 t: 415.856.3000
 San Francisco, CA 94107 f: 415.856.3001
 www.perkinswill.com

PERKINS
+ WILL

Item #	Item	Resp.	Due
	<p>spaces of varying sizes (college council, AC-senate +/- 50 people).</p> <ul style="list-style-type: none"> Look at classroom structure & design – move to Learning focused environments to match shift in teaching. Group interaction; hubs for group work w/ reference 10-year learning community. Center for science excellence good example: need LA, GA, Speech/Humanities. Office space needs enough space to meet w/ students; breakout rooms over used. Big departments in LA. Sometimes used for classes. No area to eat lunch. Outdoor areas of LA not used. Make more attractive? Indoor areas more useful. Path of travel (P.O.T.) – Language for campus; plazas in nodes @ natural intersections of P.O.T. Develop/reinforce language @ ground plane – paving, landscape, site furniture. Would like to look like San Ramon – but takes too much time – result San Ramon – but is hodge podge; modernize existing. Capitalize on appeal of campus. Programs need to work/function – not just look nicer. Windows in music building. Cohesive architectural style but updated – more modern, not DVC bookstore! Prefer contextual approach to campus. Sprit/environments feel good on campus – keep! New structure that pulls campus together. Good access; campus is an oasis attractive ambiance until in the buildings. Maintain & enhance natural environment as education experience-creek, trees, wild turkeys. Enhance outdoor spaces. 		

PERKINS
+ WILL

Item #	Item	Resp.	Due
	<ul style="list-style-type: none"> Build on use of natural environment as educational experience. Signage on freeway – let people know Contra Costa is here! + access to campus. Approach city re: signage. No real main entrance – end up @ bus transfer station; south side looks like a historic college entry. Increase historic entry. Location of admin. – near student hub/front of campus – 2nd floor SA. Central quad area. Amphitheater ugly – mobile food bus. Activity space – Town Square? Quad – existing between library & S.A. Safety – people feeling safe @ night lighting @ new P.O.T is perfect – well lit – replicate on campus. Signage – building & way finding <ul style="list-style-type: none"> Nothing makes sense right now, esp. parking lots. Use critical thinking skills! Campanille/Sather gate – near quad. <ul style="list-style-type: none"> Sense of arrival & place. Creating memory. Vertical anchor. Operable windows/doors for individual control. Need A.C. as option – allergies; classrooms. Energy efficient systems. Consider alternate energy systems like solar – part of design of (N) buildings. Zone HVAC controls. Get ride of random storage containers. 		

APPENDIX

6.2. Meeting Minutes

185 Berry St., Suite 5100 t: 415.856.3000
 San Francisco, CA 94107 f: 415.856.3001
 www.perkinswill.com

185 Berry St., Suite 5100 t: 415.856.3000
 San Francisco, CA 94107 f: 415.856.3001
 www.perkinswill.com



Item #	Item	Resp.	Due
	<ul style="list-style-type: none"> District emphasis on sustainability. Energy efficiency – on display – ART? Automotive building should be in another location. Drop-off, Kiss & Ride, for summer kids 		
2.0	Architectural Options		
	<ol style="list-style-type: none"> Armory Scheme <ul style="list-style-type: none"> Move fields to armory site (land from city). Build leasable space adjacent to (E) field locations. Relocate portion of road to develop more pedestrian center. MESA scheme <ul style="list-style-type: none"> MEGA bldg. near campus center. ARTS Quad <ul style="list-style-type: none"> Variation on armory scheme w/ ARTS bldg(s) concentrated near road adjacent to leasable area. Armory Scheme variation <ul style="list-style-type: none"> Different road re-route – less intrusive into armory site. Road Scheme within campus <ul style="list-style-type: none"> 1 Loop 2 Loop Selected demo of AA bldg. <ul style="list-style-type: none"> Clip @ road ART bldg. behind music bldg. on top of hill (or adj. to music bldg). <ul style="list-style-type: none"> Close proximity to music bldg. is a plus. New bldg. @ tennis court area adj. to road. Structural 		

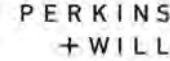

Item #	Item	Resp.	Due
	<ol style="list-style-type: none"> SA trenching results ok to keep bldg. <ol style="list-style-type: none"> May still DEMO & build bigger & better. Create new entry sequence/drop off that fronts bldg. Re-arrange parking. Bldg could be w/ plaza in front or directly adj. to drive. Bldg. farther up hill – harder to service. Maybe keep SA bldg & build new bldg. farther up the hill. If SA site has trace fault, new bldg must be built farther up the hill/MESA, plaza in front. 		

cc: Project File
 Consultants:
 Don Gray Kleinfelder, Inc.
 Glenn Claycomb Alfatech Cambridge
 Joe Sutton DASSE Design Inc.
 Peter Wrona DASSE Design Inc.
 Philip Thwin Alfatech Cambridge
 Sam Evison Davis Langdon
 Chris Guillard CMG

The foregoing constitutes our understanding of matters discussed and conclusions reached. Other participants are requested to review these items and advise the originator in writing of any errors or omissions.

P:\SanFrancisco\496022.000 CCC\DOCS\01.0-PredesignPlanProg\01.07-InterviewNotes\Meeting Minutes\070329_MM_CCC_MtgNo5_Charette.doc

185 Berry St., Suite 5100 t: 415.856.3000
 San Francisco, CA 94107 f: 415.856.3001
 www.perkinswill.com

185 Berry St., Suite 5100 t: 415.856.3000
 San Francisco, CA 94107 f: 415.856.3001
 www.perkinswill.com

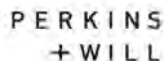

Meeting Minutes

To:	File 3.03	Date:	04/17/2007
From:	Karen Cribbins-Kuklin	Project Name:	CCC Master Plan
Date of Meeting:	04/09/07	Project No:	496022
Location:	CCC Campus	Subject:	CCC Meeting No. 6

Attendees:

Name	Company	Email address
✓ McKinley Williams (MW)	CCC	mwilliams@contracosta.edu
✓ Carol Maga (CM)	CCC	cmaga@contracosta.edu
✓ Teresa Greenwell (TG)	CCC	tgreenwell@4cd.net
Bruce King	CCC	bking@contracosta.edu
Terence Elliott	CCC	telliott@contracosta.edu
Mariles Magalong	CCC	mmagalong@contracosta.edu
Mercy Pono	CCC	mpono@contracosta.edu
✓ Kindred Murillo	CCC	kmurillo@4cd.net
✓ Mario Rebolz	Parsons Brinkerhoff	rebholz@pbworld.com
✓ Bruce Rich (BR)	Parsons Brinkerhoff	richb@pbworld.com
✓ Karen Cribbins-Kuklin (KCK)	P+W	Karen.Kuklin@perkinswill.com
✓ Susan Seastone	P+W	Susan.seastone@perkinswill.com
✓ Hyuek Rhee	P+W	Hyuek.rhee@perkinswill.com
Nick Seierup	P+W	Nick.seierup@perkinswill.com
✓ Don Gray	Kleinfelder	DGray@kleinfelder.com

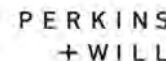

Item #	Item	Resp.	Due
1.0	<p>Geotechnical Findings</p> <p>DG stated that the SA building as been cleared of faults with a minor caveat. He said the CGS (California Geologic Survey) requested a little more trenching at the east end of the AP Zone. CGS has also told DG that additional faults could be located at 30 degree angles to the main fault lines and some additional trenching is required in some areas for complete clearance.</p> <p>CGS also wants to look at aerial photos near the AA Building. There is concern regarding poor seismic soil conditions in this area that may show up on aerial photographs.</p> <p>DG stated that trenching is now occurring near the gym and should be complete by week's end. DG suggested additional trenching be done near the old high school as well to possibly clear more area.</p>		
2.0	<p>Athletic Fields</p> <p>MW stated the importance of having the athletic fields contiguous and not separated by structures or streets. He requested a combined football and soccer field. MW explained that if the area of the armory and high school were negotiated for the college, the college would both own and maintain that property. P+W to study options.</p> <p>MW explained that the city paid for the lighting of the soccer and football fields that now exist.</p>		
3.0	<p>Traffic Issues</p> <p>MW explained how the parts of the College loop road are currently being used as a shortcut by some vehicular traffic to access the Hilltop Mall. MW would like to discourage this in the new Master Plan design. Some of the suggested changes to the loop road allow for this. Another option is to install removable bollards in some locations which would allow fire truck access but restrict vehicular access otherwise. P+W to study options.</p> <p>Additional drop off areas were requested at the South entrance and one closer to the campus core. P+W to study options.</p>		

APPENDIX

6.2. Meeting Minutes

185 Berry St., Suite 5100 t: 415.856.3000
 San Francisco, CA 94107 f: 415.856.3001
www.perkinswill.com

185 Berry St., Suite 5100 t: 415.856.3000
 San Francisco, CA 94107 f: 415.856.3001
www.perkinswill.com



Item #	Item	Resp.	Due
4.0	<p>Automotive Area</p> <p>Different issues were discussed regarding the VA Building and the Auto Tech program. One suggestion was to put a screen in front of the VA Building to hide some unsightly items as a temporary measure. The issue of possible soil contamination caused by that program was discussed. Renovation of the VA Building to serve another program was discussed. P+W to study options.</p>		
6.0	<p>Miscellaneous Comments</p> <p>KCK captured the groups comments related to the schemes and other possibilities on the actual boards. Pdfs of the boards are posted to the ftp site.</p>		
7.0	<p>Option A</p> <p>PROS</p> <ul style="list-style-type: none"> All Fields contiguous (requires change to plan) Clipping AA bldg. -> good for traffic Take advantage of hillside @ lower level <p>CONS</p> <ul style="list-style-type: none"> Parking needs to be accommodated for fields Working out traffic on all sides of AA bldg. needs to happen – several issues exist Plaza – hard to visualize since not all at one level -> sloping site Automotive next to SA – doesn't seem right. Need to move out of area where plaza exists <ul style="list-style-type: none"> ART bldg not an appropriate location Armory bldg may be good -> high bay exists already A lot of excavation required for SA bldg 		

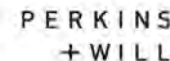

Item #	Item	Resp.	Due
8.0	<p>Option B</p> <p>PROS</p> <ul style="list-style-type: none"> Less excavation required for SA building. Foundation would be in deeply weathered rock for SA bldg. -> solid. Drop-off Entry area should be big enough to convey sense of arrival & function from a traffic perspective <p>CONS</p> <ul style="list-style-type: none"> Creek & plaza as shown overlap -> creates design challenge -> could be a PRO. Does not create front door on perimeter – no schemes address this issue. 		
8.0	<p>Option C</p> <p>Not reviewed in detail</p>		
9.0	<p>Option D</p> <p>PROS</p> <ul style="list-style-type: none"> New SA and Admin. building that accommodates many of the programs – great idea Likes SA bldg shape, maybe better with Option B new LA bldg. orientation instead of classroom bldg as shown ART bldg. next to Music -> good Automotive along public perimeter – good idea Mission Bell would be appropriate not El Portal Armory location would also be good <p>CONS</p> <ul style="list-style-type: none"> Auto-tech doesn't work in ART bldg Automotive area may not be a good companion to a campus entry 		

185 Berry St., Suite 5100 t: 415.856.3000
 San Francisco, CA 94107 f: 415.856.3001
 www.perkinswill.com

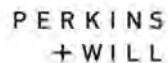

Item #	Item	Resp.	Due
	<ul style="list-style-type: none"> Automotive recently improved -> may not be high priority to relocate 		
10.0	<p>Next Steps</p> <p>P+W will consolidate schemes based on comments made today for a meeting on April 13th at 3:30 with this same group.</p>		

cc: Project File
 Attendees
 CCC Project Team
 CCC Consultants:
 Glenn Claycomb Alfatech Cambridge
 Joe Sutton DASSE Design Inc.
 Peter Wrona DASSE Design Inc.
 Philip Thwin Alfatech Cambridge
 Sam Evison Davis Langdon
 Chris Guillard CMG

The foregoing constitutes our understanding of matters discussed and conclusions reached. Other participants are requested to review these items and advise the originator in writing of any errors or omissions.

P:\SanFrancisco\496022.000 CCC\DOCS\01.0-PreDesignPlanProg\01.07-InterviewNotes\Meeting Minutes\070409_MM_CCC_MtgNo6.doc

APPENDIX

6.2. Meeting Minutes

185 Berry St., Suite 5100 t: 415.856.3000
 San Francisco, CA 94107 f: 415.856.3001
www.perkinswill.com

185 Berry St., Suite 5100 t: 415.856.3000
 San Francisco, CA 94107 f: 415.856.3001
www.perkinswill.com

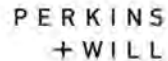

Meeting Minutes

To:	File 3.03	Date:	04/24/2007
From:	Karen Cribbins-Kuklin	Project Name:	CCC Master Plan
Date of Meeting:	04/19/07	Project No:	496022
Location:	CCC Campus	Subject:	CCC Meeting No. 8

Attendees:		
Name	Company	Email address
✓ McKinley Williams (MW)	CCC	mwilliams@contracosta.edu
✓ Carol Maga (CM)	CCC	cmaga@contracosta.edu
Teresa Greenwell (TG)	CCC	tgreenwell@4cd.net
Bruce King	CCC	bking@contracosta.edu
Terence Elliott	CCC	telliott@contracosta.edu
Mariles Magalong	CCC	mmagalong@contracosta.edu
Mercy Pono	CCC	mpono@contracosta.edu
✓ Kindred Murillo	CCC	kmurillo@4cd.net
✓ Lourdes Sampayo	CCC	lourdes292@aol.com
Mario Rebholz	Parsons Brinkerhoff	rebholz@pbworld.com
Bruce Rich (BR)	Parsons Brinkerhoff	richb@pbworld.com
✓ Karen Cribbins-Kuklin (KCK)	P+W	Karen.Kuklin@perkinswill.com
✓ Susan Seastone	P+W	Susan.seastone@perkinswill.com
✓ Hyuek Rhee	P+W	Hyuek.rhee@perkinswill.com
Nick Seierup	P+W	Nick.seierup@perkinswill.com
Don Gray	Kleinfelder	DGray@kleinfelder.com

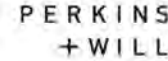

Item #	Item	Resp.	Due
1.0	<p>Schemes Presented</p> <p>KCK presented 3 schemes showing the same building configuration but different roadway configurations. The schemes presented showed:</p> <ol style="list-style-type: none"> 1) a new classroom building 2) a new science building 3) a new student administration building 4) a renovated biology building converted into a new art building 5) a renovated art building converted into a new operations and maintenance building 6) a renovated physical science building into a new shared college/ community facility 7) an upgraded applied arts and administration building 8) a demolished operations and maintenance building 		
2.0	<p>Comments on Schemes</p> <p>The schemes presented prompted discussion of the following issues:</p> <ol style="list-style-type: none"> 1) Several people thought the physical science building should be considered for maintenance, reprographics, police, and receiving functions. MW was uncomfortable with moving central receiving to this location. Vehicular access to this area for large trucks to maneuver would be difficult. 2) MW asked KM what might happen to the \$2 million received by the State for retrofit of the art building. KM thought a case could be made to the State to re-scope that money for another purpose. 3) CM reminded everyone that in the current art building location the art program's ceramics department could not increase the outdoor area for kilns because of the limitations on increasing square footage in the existing regulations. 4) KM stated that demolishing some area on campus would 	P+W	

185 Berry St., Suite 5100 t: 415.856.3000
 San Francisco, CA 94107 f: 415.856.3001
 www.perkinswill.com

185 Berry St., Suite 5100 t: 415.856.3000
 San Francisco, CA 94107 f: 415.856.3001
 www.perkinswill.com

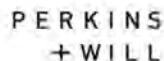

Item #	Item	Resp.	Due
	<p>help in keeping the campus ratios in proper alignment with state guidelines.</p> <p>5) CM explained that the existing containers on-site were basically in the correct locations on the campus to serve specific needs. The art and robotics containers could be relocated but the others should remain in their current locations</p> <p>6) MW stated that he thought the conversion of the biology building to an art building made sense. KCK stated that the civil engineer, BKF, would study the area near the art building for truck maneuverability.</p> <p>7) The applied arts and administration building will need to be renovated to remove some programs, add other programs, improve circulation, address seismic issues, and provide a general finish upgrade. The arts and administration building may house the mail and reprographics areas as well as math and technology. Culinary arts would move to the new student administration building. Mail could also stay in the student administration building.</p> <p>8) KS stated that the area near the art building would need to be investigated for faults even if it outside the AP zone if it were to be used for a building serving students and classroom functions.</p> <p>9) The general consensus was to revise the "L" shaped building to a different massing shape.</p> <p>10) CM suggested repurposing the physical sciences building closest to the road to space that could both serve the campus as well as the community. Everyone agreed this was a good strategy. The physical sciences structure more central to the campus could be demolished to create a science/ art plaza.</p> <p>11) All agreed that a bridge across the creek connecting the music and new art (old biology) building would be a great idea.</p> <p>12) Some suggested swapping the locations of the science and classroom buildings. This was discouraged based on the</p>		

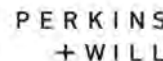

Item #	Item	Resp.	Due
	<p>easier ability to service the science building in its current location and the fact that the classroom building would most likely not require a service dock.</p> <p>13) The need for a green house was discussed but the perfect location was not determined. It would probably want to be located close to the science building. KCK stated that these structures tended to be slightly unsightly and their location should be carefully thought out.</p>		
3.0	<p>Room Usage Report</p> <p>KM enquired about the status of the report. KCK stated that it would be completed shortly and the draft was being completed today.</p>	P+W	
4.0	<p>Phasing</p> <p>The construction phasing for the new buildings would be the following:</p> <ol style="list-style-type: none"> 1) demolish existing student administration building and humanities building 2) build classroom building, student administration building, and arts and administration remodel 3) build science building 4) convert biology building to art building 5) build arts building remodel to operations and maintenance 6) demolish existing operations and maintenance building 		
5.0	<p>Miscellaneous Comments</p> <p>150 people exist in the International Program</p>		
6.0	<p>Next Steps</p> <p>P+W will consolidate schemes based on comments made today for a meeting on April 27th at 1:00 with the College Council. A conference call will be arranged on Thursday, April 26th to preview the landscape ideas. There will be no meeting with the College on April 30th. The next Monday meeting with the College will be on May 7th. May 9th is the next official College Council meeting.</p>		

APPENDIX

6.2. Meeting Minutes

185 Berry St., Suite 5100 t: 415.856.3000
 San Francisco, CA 94107 f: 415.856.3001
www.perkinswill.com

185 Berry St., Suite 5100 t: 415.856.3000
 San Francisco, CA 94107 f: 415.856.3001
www.perkinswill.com

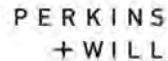

Meeting Minutes

To:	File 1.07	Date:	05/31/07
From:	Susan Seastone	Project Name:	CCC Master Plan
Date of Meeting:	05/07/07	Project No:	496022
Location:	CCC Campus	Subject:	CCC Meeting No. 9

Attendees:

Name	Company	Email address
✓ McKinley Williams (MW)	CCC	mwilliams@contracosta.edu
✓ Carol Maga (CM)	CCC	cmaga@contracosta.edu
✓ Teresa Greenwell (TG)	CCC	tgreenwell@4cd.net
✓ Bruce King	CCC	bking@contracosta.edu
Terence Elliott	CCC	telliott@contracosta.edu
Mariles Magalong	CCC	mmagalong@contracosta.edu
Mercy Pono	CCC	mpono@contracosta.edu
✓ Kindred Murillo	CCC	kmurillo@4cd.net
Lourdes Sampayo	CCC	lourdes292@aol.com
Mario Rebholz	Parsons Brinkerhoff	rebholz@pbworld.com
✓ Bruce Rich (BR)	Parsons Brinkerhoff	richb@pbworld.com
✓ Karen Cribbins-Kuklin (KCK)	P+W	Karen.Kuklin@perkinswill.com
✓ Susan Seastone	P+W	Susan.seastone@perkinswill.com
Hyuek Rhee	P+W	Hyuek.rhee@perkinswill.com
Nick Seierup	P+W	Nick.seierup@perkinswill.com
Don Gray	Kleinfelder	DGray@kleinfelder.com
✓ Marcia Vallier	Vallier Design Associates	Marcia@vallierdesign.com
✓ Jessie Maran	Vallier Design Associates	jessie@vallierdesign.com
✓ Chris Guillard	CMG	cguillard@cmgsite.com
✓ Jamie Phillips	CMG	jphillips@cmgsite.com

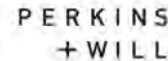

Item #	Item	Resp.	Due
1.0	Landscape Coordination Meeting		
	1) TG introduced Marcia Vallier and explained that MV worked on the previous master plan with TBP and 3 specific projects on the campus. They have also developed some standards for signage (interior and exterior), landscape (hardscape and softscape), color palettes (buildings and hardscape) for the campus. MV will forward these standards to P+W for review. MV explained that they are not currently formatted into a complete and stand alone package.	MV	
	2) The Mills Avenue parking lot area was discussed. CG presented some ideas CMG has been developing for the area to provide a new organization to the parking area as well as a drop-off.		
	3) CMG expressed their interest in creating a design that would bring the existing stream visibly through the new plaza area. They also discussed the ability to activate the space with an exterior café that could be run by the Culinary Program.		
	4) CMG described a design concept that would integrate an amphitheatre into the back of the new SA Building. There may be a roll-up door with a stage area on the interior of the new SA Building. The amphitheater could be made of a combination on concrete seat walls and grass to make it more usable for a variety of functions.		
	5) MV will forward an AutoCad copy of the current plaza design at the new SS Building to CMG and copy SS at P+W. All agreed that the current design for the new SS plaza could be built as designed and would then later be modified to correspond to the Master Plan at a later date.	MV	
	6) KK recommended a traffic study be contracted to understand the frequency of use at the entries, drop-off, parking, etc.		
	7) MW stated that he wants the campus architectural style to be unified in scale and color. The use of contextual materials, brick and stucco, is important.		
	8) MW stated that he was concerned about the attempt to tie		

185 Berry St., Suite 5100 t: 415.856.3000
 San Francisco, CA 94107 f: 415.856.3001
www.perkinswill.com



Item #	Item	Resp.	Due
	the Music and new Art (current Biology) Buildings together with a bridge. He likes the bridge idea but thinks the landscaping also requires some attention and maybe reduction.		
9)	The new SS Building is clad in brick, stucco, and metal panel. The brick is not actual brick but instead a ½" brick look alike material adhered to an underlayment.		

cc: Project File
 Attendees
 CCC Project Team
 CCC Consultants:
 Glenn Claycomb Alfatech Cambridge
 Joe Sutton DASSE Design Inc.
 Peter Wrona DASSE Design Inc.
 Philip Thwin Alfatech Cambridge
 Sam Evison Davis Langdon

The foregoing constitutes our understanding of matters discussed and conclusions reached. Other participants are requested to review these items and advise the originator in writing of any errors or omissions.

P:\SanFrancisco\496022.000 CCC\DOCS\01.0-PreDesignPlanProg\01.07-InterviewNotes\Meeting Minutes\070507_MM_CCC_MtgNo9.doc

APPENDIX

6.2. Meeting Minutes

185 Berry St., Suite 5100 t: 415.856.3000
 San Francisco, CA 94107 f: 415.856.3001
www.perkinswill.com

185 Berry St., Suite 5100 t: 415.856.3000
 San Francisco, CA 94107 f: 415.856.3001
www.perkinswill.com



Meeting Minutes

To:	File 1.07	Date:	05/31/07
From:	Susan Seastone	Project Name:	CCC Master Plan
Date of Meeting:	05/07/07	Project No:	496022
Location:	CCC Campus	Subject:	CCC Meeting No. 10

Attendees:		
Name	Company	Email address
✓ McKinley Williams (MW)	CCC	mwilliams@contracosta.edu
✓ Carol Maga (CM)	CCC	cmaga@contracosta.edu
✓ Teresa Greenwell (TG)	CCC	tgreenwell@4cd.net
✓ Bruce King	CCC	bking@contracosta.edu
Terence Elliott	CCC	telliott@contracosta.edu
Mariles Magalong	CCC	mmagalong@contracosta.edu
Mercy Pono	CCC	mpono@contracosta.edu
✓ Kindred Murillo	CCC	kmurillo@4cd.net
Lourdes Sampayo	CCC	lourdes292@aol.com
Mario Rebholz	Parsons Brinkerhoff	rebholz@pbworld.com
✓ Bruce Rich (BR)	Parsons Brinkerhoff	richb@pbworld.com
✓ Karen Cribbins-Kuklin (KCK)	P+W	Karen.Kuklin@perkinswill.com
✓ Susan Seastone	P+W	Susan.seastone@perkinswill.com
Hyuek Rhee	P+W	Hyuek.rhee@perkinswill.com
Nick Seierup	P+W	Nick.seierup@perkinswill.com
Don Gray	Kleinfelder	DGray@kleinfelder.com



Item #	Item	Resp.	Due
1.0	<p>Overview of College Counsel Meeting</p> <p>KK noted the input received at the College Counsel Meeting.</p> <ol style="list-style-type: none"> The amphitheater will move north away from the library and integrate more into the main plaza area. An amphitheater that integrates softer landscape is desirable. The bridge connection between the existing Music Building and new Art Building is important. The new Operations & Maintenance Building location (old Art Building) is currently being reviewed for any truck access issues by BKF. 		
2.0	<p>Miscellaneous Master Plan Details</p> <ol style="list-style-type: none"> KK explained that she received a request to modify the fence around the athletic field from John. All agreed that a fence upgrade and standard should be included in the Master Plan. CMG explained that they would like to design the main entry plaza area to integrate with the existing stream and eliminate the culvert. KK explained that each campus entry would be marked with the same architectural kiosk feature in order create a cohesive entry language. KK explained that as the documentation for each phase of the project progresses, Perkins + Will would recommend a strategy that packages building projects with adjacent site work, accessibility, and fire department access. All agreed that the Master Plan would not assume the acquisition of the 2 city parcels in a timely way. Operations and Maintenance may be able to be relocated to these parcels depending on timing and the condition of the available buildings. MW volunteered that the parking area at the current Art Building can be reduced since it is not utilized fully. The Police Department requires approximately 40' x 40' of space with parking for 3 police cars and additional 		

185 Berry St., Suite 5100 t: 415.856.3000
 San Francisco, CA 94107 f: 415.856.3001
 www.perkinswill.com

185 Berry St., Suite 5100 t: 415.856.3000
 San Francisco, CA 94107 f: 415.856.3001
 www.perkinswill.com

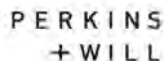

Item #	Item	Resp.	Due
	<p>personal vehicles. A final location for this group can be studied as programming progresses.</p> <p>8. The Mail room could be moved from the SA Building to another location.</p> <p>9. Media Services and Student Health Services should stay in the SA Building.</p> <p>10. The AA Building will continue to house the Math, Speech, Debate, AJ, and TV Programs. The AA Culinary space could be considered for a community space.</p> <p>11. BR stated that the Educational Plan needs to be tied to the Master Plan. Perkins + Will will integrate them. MW stated that the Educational Plan would be completed during the week of May 14th and provided to P+W. This integration should show how currently some CCCC campus spaces do not align with district guidelines.</p>	P+W, MW	
3.0	<p>Schedule</p> <p>1. KM stated that the Final Geotech Report needs to be issued before the Master Plan can be completed and presented to the Chancellor's Office. She is targeting late July or early August to review the Master Plan with the Chancellor's office. Only one scope revision should be presented to the Department of Finance as well.</p> <p>2. Next progress update is scheduled with this group for May 14th</p> <p>3. The Room Usage Analysis will be reviewed on May 21st.</p>		
4.0	<p>Phasing</p> <p>1. BR suggested that construction in the campus center that may want to occur simultaneously to minimize disruption to the campus. P+W to study.</p> <p>2. MW stated that he does not recommend the use of any swing spaces because that strategy is too disruptive to students.</p>	P+W	

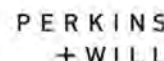

cc: Project File

Attendees

CCC Project Team

CCC Consultants:

Glenn Claycomb	Alfatech Cambridge
Joe Sutton	DASSE Design Inc.
Peter Wrona	DASSE Design Inc.
Philip Thwin	Alfatech Cambridge
Sam Evison	Davis Langdon
Chris Guillard	CMG

The foregoing constitutes our understanding of matters discussed and conclusions reached. Other participants are requested to review these items and advise the originator in writing of any errors or omissions.

P:\SanFrancisco\496022.000 CCC\DOCS\01.0-PredesignPlanProg\01.07-InterviewNotes\Meeting Minutes\070507_MM_CCC_MtgNo10.doc

APPENDIX

6.2. Meeting Minutes

185 Berry St., Suite 5100 t: 415.856.3000
 San Francisco, CA 94107 f: 415.856.3001
www.perkinswill.com

185 Berry St., Suite 5100 t: 415.856.3000
 San Francisco, CA 94107 f: 415.856.3001
www.perkinswill.com



Meeting Minutes

To:	File 1.07	Date:	05/31/07
From:	Susan Seastone	Project Name:	CCC Master Plan
Date of Meeting:	05/21/07	Project No:	496022
Location:	CCC Campus	Subject:	CCC Meeting No. 11

Attendees:		
Name	Company	Email address
✓ McKinley Williams (MW)	CCC	mwilliams@contracosta.edu
✓ Carol Maga (CM)	CCC	cmaga@contracosta.edu
✓ Teresa Greenwell (TG)	CCC	tgreenwell@4cd.net
✓ Bruce King	CCC	bking@contracosta.edu
Terence Elliott	CCC	telliott@contracosta.edu
Mariles Magalong	CCC	mmagalong@contracosta.edu
Mercy Pono	CCC	mpono@contracosta.edu
✓ Kindred Murillo	CCC	kmurillo@4cd.net
Lourdes Sampayo	CCC	lourdes292@aol.com
Mario Rebholz	Parsons Brinkerhoff	rebholz@pbworld.com
Bruce Rich (BR)	Parsons Brinkerhoff	richb@pbworld.com
✓ Karen Cribbins-Kuklin (KCK)	P+W	Karen.Kuklin@perkinswill.com
✓ Susan Seastone	P+W	Susan.seastone@perkinswill.com
Hyuek Rhee	P+W	Hyuek.rhee@perkinswill.com
Nick Seierup	P+W	Nick.seierup@perkinswill.com
Don Gray	Kleinfelder	DGray@kleinfelder.com



Item #	Item	Resp.	Due
1.0	Space Inventory Spreadsheet Review <ol style="list-style-type: none"> KK explained the spreadsheet describing the space inventory to be included in the Master Plan. BR and others became concerned that some assignable square feet numbers given in this spreadsheet may be inaccurate and others were not provided. BR will confirm numbers and forward to P+W by June 1. SS will revise spreadsheet to include a column representing areas that are considered instructional space. Instructional space would include lecture, lab, and audio visual space but not office or library. Storage spaces are also not considered instructional. 	BR SS	
2.0	Miscellaneous <ol style="list-style-type: none"> Perkins + Will was made aware that a plan exists for the Math Department move to the AA Building by Integrated Resources. The renovated Library design was done by Noll + Tam. BR will provide these plans in the next phase of the project, programming. The college let P + W know that the new Student Services building has no instructional space in its program. CM will provide a report to P+W that identifies each classroom hourly usage in order for P+W to finish Usage Report. KK and CM will meet on May 22 to allow CM to identify department's usage of space in each building. The Fireside Room in the existing SA Building holds 200-300 people. The new SA Building will need separate spaces for the Culinary Program and the Cafeteria serving the general population. The Campus Standards that were produced by Marsha Vallier have still not been forwarded to P+W by BR for incorporation into the Master Plan; therefore, the draft Master Plan to be printed on May 31st will not include the standards sections. TG and BR will confirm that all AutoCad plans for each 	BR CM KK, CM BR	

185 Berry St., Suite 5100 t: 415.856.3000
 San Francisco, CA 94107 f: 415.856.3001
 www.perkinswill.com

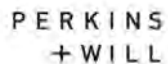

Item #	Item	Resp.	Due
	existing building are updated with accurate wall locations. They will forward drawings to P+W once they have been updated and P+W could color code to match the 5 categories of space type the Chancellor's Department recognizes.	BR, TG	

- cc: Project File
 Attendees
 CCC Project Team
 CCC Consultants:
 Glenn Claycomb Alfatech Cambridge
 Joe Sutton DASSE Design Inc.
 Peter Wrona DASSE Design Inc.
 Philip Thwin Alfatech Cambridge
 Sam Evison Davis Langdon
 Chris Guillard CMG

The foregoing constitutes our understanding of matters discussed and conclusions reached. Other participants are requested to review these items and advise the originator in writing of any errors or omissions.

P:\SanFrancisco\496022.000 CCC\DOCS\01.0-PredesignPlanProg\01.07-InterviewNotes\Meeting Minutes\070521_MM_CCC_MtgNo11.doc

APPENDIX

6.2. Meeting Minutes

185 Berry St., Suite 5100 t: 415.856.3000
 San Francisco, CA 94107 f: 415.856.3001
www.perkinswill.com

185 Berry St., Suite 5100 t: 415.856.3000
 San Francisco, CA 94107 f: 415.856.3001
www.perkinswill.com

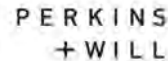

Meeting Minutes

To:	File 1.07	Date:	07/02/07
From:	Susan Seastone	Project Name:	CCC Master Plan
Date of Meeting:	06/19/07	Project No:	496022
Location:	CCC Campus	Subject:	CCC Meeting No. 12

Attendees:

Name	Company	Email address
✓ McKinley Williams (MW)	CCC	mwilliams@contracosta.edu
✓ Carol Maga (CM)	CCC	cmaga@contracosta.edu
✓ Teresa Greenwell (TG)	CCC	tgreenwell@4cd.net
Bruce King	CCC	bking@contracosta.edu
Terence Elliott	CCC	telliott@contracosta.edu
Mariles Magalong	CCC	mmagalong@contracosta.edu
Mercy Pono	CCC	mpono@contracosta.edu
Kindred Murillo	CCC	kmurillo@4cd.net
Lourdes Sampayo	CCC	lourdes292@aol.com
✓ Mario Reholz	Parsons Brinkerhoff	reholz@pbworld.com
Bruce Rich (BR)	Parsons Brinkerhoff	richb@pbworld.com
✓ Karen Cribbins-Kuklin (KCK)	P+W	Karen.Kuklin@perkinswill.com
✓ Susan Seastone	P+W	Susan.seastone@perkinswill.com
Hyuek Rhee	P+W	Hyuek.rhee@perkinswill.com
Nick Seierup	P+W	Nick.seierup@perkinswill.com
Don Gray	Kleinfelder	DGray@kleinfelder.com



Item #	Item	Resp.	Due
1.0	<p>Master Plan Review Comments</p> <p>MW and CM volunteered that they have not had time to read the report in detail. They would like a chance to give detailed comments on Wednesday, June 27th but some comments were discussed and are outlined below.</p> <ol style="list-style-type: none"> MW asked if the format could be made easier to understand. He didn't follow the logic for which side of the page the text appeared. P + W to modify report. KCK stated that she received a few comments from Bruce Rich requesting that the front end sections be enhanced because they were "thin." She and Bruce also discussed the addition of a geotech summary and a section dedicated to accessibility. P+W to modify report. KCK also stated that the room usage report would be added to the report but it has not yet been finalized. P+W to modify report. MW and CM stated that programs and not facilities would address the issue of promoting the mixing ethnic groups within the college environment. MW requested that the college's mission statement be added to the Master Plan. P+W to modify report. CM asked that the Castro Street Entry be mentioned in the report as a major entrance to the college. P+W to modify report. Several people requested identifying some of the civil infrastructure work as independent projects. P+W to modify report. MW is concerned that the listing of metal panels as a secondary building material in the current report will result in metal panel being used in inappropriate amounts to blend with the existing context of the campus. The master Plan will be modified to clearly identify stucco and brick as the primary exterior cladding materials with metal panel just being utilized for soffits and roof screens. KCK and SS explained that pre-cast concrete panel systems will provide a higher quality and longer lasting building than stucco and that they may 	P+W	

185 Berry St., Suite 5100 t: 415.856.3000
 San Francisco, CA 94107 f: 415.856.3001
 www.perkinswill.com

185 Berry St., Suite 5100 t: 415.856.3000
 San Francisco, CA 94107 f: 415.856.3001
 www.perkinswill.com

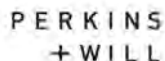

Item #	Item	Resp.	Due
	<p>want to be considered as an option. MW asked that concrete not be considered a this time as an exterior cladding material. EIFS (Exterior Insulation Finish system) was also discussed as an exterior cladding system. KCK explained that this system has the appearance of stucco but is inferior to it. All agreed that the Master Plan should specifically exclude this material from being considered as a cladding system in the Master Plan. P+W will make modifications requested to the report.</p> <p>9) P+W will add more information regarding campus disabled accessibility to the MP. This may take the form of a separate section or may be included as part existing sections. A diagram will also include information regarding accessibility.</p> <p>10) Signage standards will be added to the MP. TG explained that Vallier Design did not do a location plan for exterior signage but only standardized text fonts and colors. Items included in MP will be clarified at a future standards meeting. Everyone agreed that all future interior signage should not utilize blue as a standard color since it may conflict with interior color schemes developed for individual buildings.</p> <p>11) TG requested that the window system metal and glass be standardized. P+W to add info to MP.</p> <p>12) P+W will clarify that the plan arc in the MP building forms is not a requirement of the final design.</p> <p>13) Student Activities Health Services can not fit in new SS Building- another location must be identified. P+W to study. Approximately 1,000gsf is required. The new SA Building or the existing AA Building should be considered.</p> <p>14) Note to maintain accessible path of travel during construction will be added to section 4.2 by P+W.</p> <p>15) P+W to coordinate a new loading and large truck access way at existing Art Building with civil and revise the graphic.</p>		

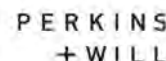

Item #	Item	Resp.	Due
	<p>16) On-going projects including the new Student Services Building, Library upgrade, new fence, parking lot PVs, and some accessibility updates will not be part of the MP but will be assumed to be complete prior to the commencement of the MP work.</p> <p>17) Phasing comments from a previous meeting with KCK will be addressed for the final version of the MP.</p> <p>18) To date the CGS Report has not been issued. The CGS Report will need to be coordinated with the MP when complete.</p>		
2.0	<p>Issues for Kindred</p> <p>Several issues involving the Chancellor's Office need to be clarified by Kindred.</p> <ol style="list-style-type: none"> 1. Can the funds allocated for building improvements in the existing Art Building be transferred to the new Art Building (old Biology) and the time frame for their expenditure extended to allow for this project to happen a few years from now? 2. Is there a Chancellor's Office funding deadline on July 1 that CCC needs to be concerned about? 	KM	
3.0	<p>Next Steps</p> <p>A MP Standards Meeting is set for 10:00am on July 27th.</p>		

cc: Project File

Attendees

CCC Project Team

CCC Consultants:

Glenn Claycomb	Alfatech Cambridge
Joe Sutton	DASSE Design Inc.
Peter Wrona	DASSE Design Inc.
Philip Thwin	Alfatech Cambridge
Sam Evison	Davis Langdon
Chris Guillard	CMG
Jamie Phillips	CMG

APPENDIX

6.2. Meeting Minutes

185 Berry St., Suite 5100 t: 415.856.3000
 San Francisco, CA 94107 f: 415.856.3001
 www.perkinswill.com

185 Berry St., Suite 5100 t: 415.856.3000
 San Francisco, CA 94107 f: 415.856.3001
 www.perkinswill.com

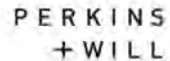

Meeting Minutes

To:	File 1.07	Date:	07/02/07
From:	Susan Seastone	Project Name:	CCC Master Plan
Date of Meeting:	06/27/07	Project No:	496022
Location:	CCC Campus	Subject:	CCC Meeting No. 13

Attendees:		
Name	Company	Email address
✓ McKinley Williams (MW)	CCC	mwilliams@contracosta.edu
✓ Carol Maga (CM)	CCC	cmaga@contracosta.edu
✓ Teresa Greenwell (TG)	CCC	tgreenwell@4cd.net
Bruce King	CCC	bking@contracosta.edu
Terence Elliott	CCC	telliott@contracosta.edu
Mariles Magalong	CCC	mmagalong@contracosta.edu
Mercy Pono	CCC	mpono@contracosta.edu
Kindred Murillo	CCC	kmurillo@4cd.net
Lourdes Sampayo	CCC	lourdes292@aol.com
✓ Mario Rebholz	Parsons Brinkerhoff	rebholz@pbworld.com
✓ Bruce Rich (BR)	Parsons Brinkerhoff	richb@pbworld.com
✓ Karen Cribbins-Kuklin (KCK)	P+W	Karen.Kuklin@perkinswill.com
✓ Susan Seastone	P+W	Susan.seastone@perkinswill.com
Hyuek Rhee	P+W	Hyuek.rhee@perkinswill.com
Nick Seierup	P+W	Nick.seierup@perkinswill.com
✓ Jamie Phillips	CMG	jphillips@cmgsite.com
✓ Marcia Vallier	Vallier Design Associates	marcia@vallierdesign.com
✓ Jessie Maran	Vallier Design associates	jessie@vallierdesign.com
Don Gray	Kleinfelder	DGray@kleinfelder.com



Item #	Item	Resp.	Due
1.0	<p>Meeting Purpose</p> <p>The purpose of this meeting was to let Vallier Design Associates explain the current campus standards that they have developed and let the College have an opportunity to comment on whether those standards are still current and approved. The following are the items that were presented and modifications discussed:</p> <ol style="list-style-type: none"> 1) The Exterior Color Palette Standards developed for the building exteriors was presented. MV explained that they used the Munsell Color System as the basis for their selections. Most building colors are earth tones or in the warm grey neutral range but a brickish red and a dark blue were also included. Much discussion regarding the blue ensued. In general the blue is not well liked and should be thought of as a very minimally used secondary color only. Vallier will forward an electronic copy of the standards by Monday, July 2 to P+W 2) The Landscape Standards are developed around a selection of drought resistant, deer resistant, native type plant species. An overall mapping of the existing plants on-site has not been developed per MV. No arboretum plan exists per MV and TG. MV will forward landscape standards to P+W by July 2nd, 2007. 3) The Signage Standards are not currently a cohesive package. An exterior signage location plan which would identify all exterior sign locations and types of signs, does not yet exist. MVA has developed font and color only for both exterior and interior. These colors are blue, grey, and off-white with the exception of some metallic aluminum signage on the exterior. An interior signage standard based on the ASI-Modulex Messenger System has been selected. The blue color which is part of the palette can be left out if it interferes with the interior or exterior color palette. MV will forward a copy of the proposal she put together to provide a location plan to KCK and CM by Monday, July 2. 4) Interior Color and Material Palette Standards have been developed by Dovetail Decisions per TG and MW. CCC would like this info reviewed by P+W and included in the 		
		MV	
		MV	
		TG	

185 Berry St., Suite 5100 t: 415.856.3000
 San Francisco, CA 94107 f: 415.856.3001
 www.perkinswill.com

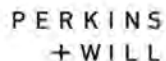

Item #	Item	Resp.	Due
	MP document as appropriate. TG will provide this info to P+W in both electronic and color board form. 5) Site Furnishing Standards including benches, trash receptacles, tables, recycling containers, etc. are identified in the draft document produced by Vallier Design Associates. A final CCC approved copy will be forwarded to P+W by Vallier on Monday, July 2 for incorporation into the MP. This date is critical for keeping the final MP printing on July 13 th .	MV	
2.0	Next Steps The Final Master Plan will be printed on Friday, July 13 th 2007 provided the information requested above is received in the times agreed. Distribution of the MP will occur on July 16 th .	P+W	

cc: Project File
 Attendees
 CCC Project Team
 CCC Consultants:
 Glenn Claycomb Alfatech Cambridge
 Joe Sutton DASSE Design Inc.
 Peter Wrona DASSE Design Inc.
 Philip Thwin Alfatech Cambridge
 Sam Evison Davis Langdon
 Brock Roby BKF
 Chris Guillard CMG

The foregoing constitutes our understanding of matters discussed and conclusions reached. Other participants are requested to review these items and advise the originator in writing of any errors or omissions.

P:\SanFrancisco\496022.000 CCC\DOCS\01.0-PreDesignPlanProg\01.07-InterviewNotes\Meeting Minutes\070627_MM_CCC_MtgNo13.doc

APPENDIX

6.3. Dovetail Design Standards

DOVETAIL DCI

Contra Costa College Interior Finishes Matrix

Finish Type/Application	Palette Options	Project Palette Selection	Application Locations
Paints			
Interior Walls Only			
Field - Primary	KM Bone - 550-27		All
Accent - Primary/Cool	KM Brompton Gray - 05-2881SP		All
Accent - Primary/Cool	Mexican Feather Grass - 05-2880SP		All
Accent - Secondary/Cool	Canterbury - 05-2882SP		All
Accent - Primary/Warm	Parchment - 05-2876SP		All
Accent - Primary/Warm	Organic Green - 05-2877SP		All
Accent - Secondary/Warm	Mount Yllarica - 05-2878SP		All
Accent - Secondary/Warm	Takoha - 05-2879SP		All
Flooring			
Resilient Flooring			
Tarkett VCT			
Field	Gray - 1334	<i>2018 Cool Gray</i>	All
Accent - Cool	Chameal - 1356		All
Accent - Cool	Dark Taupe - 1365		All
Accent - Cool	Hudson Blue - 1370	<i>Blue Gray</i>	All
Accent - Warm	Tropical Green - 1372		All
Accent - Warm	Burgundy - 1373	<i>Pomegranate Red</i>	All
Accent - Warm	Copper - 1376		All
Acoustics			
Field	TBD		All
Accent - Cool	TBD		All
Accent - Cool	TBD		All
Accent - Warm	TBD		All
Accent - Warm	TBD		All
Carpet			
Field - Primary Warm (A)	Collins & Aikman Gonymede - Voyager		All
Field - Primary Warm (B)	Collins & Aikman Olive Grove - Infinity 05849		All
Field - Primary Cool (C)	Collins & Aikman Draco - Voyager		All
Field - Primary Cool (D)	Collins & Aikman Kaleidoscope - Infinity		All
Field - Alternate Warm (A)	Mannington Sasa - Gemstone 2		All
Field - Alternate Warm (C)	Interface Rabat - Marrakesh		All
Field - Alternate Cool (D)	Mannington Brighton - Carthage 4		All
Field - Alternate Cool (D)	Interface Tunis - Marrakesh		All
Laminates			
Casework			
Horizontal Worksurfaces - Cool	Nevamar Storm Gray Matic - NR4004T		All
Vertical Cabinets - Cool	Nevamar Cafe Allusion Texture - AL2664T		All
Horizontal Worksurfaces - Warm	Wilson Art Bronze Legacy - 4656-60		All
Vertical Cabinets - Warm	Nevamar Sierra Essence - ES2003T		All
Vertical Cabinets / Doors	Panokam Hardrock Maple - HP290		All
Restroom Finishes			
Ceramic Tile			
Floor and 6" Wall Base			
Field (60%) - 2'x2'	Dal-Tile Beermans Bronze - Keystone D156	<i>Apple Grey D336</i>	All Restrooms
Accent (25%) - 2'x2'	Dal-Tile White Granite - Keystone D037	<i>Apple D336</i>	All Restrooms
Accent (15%) - 2'x2'	Dal-Tile Beermans Bronze - Keystone D147	<i>Apple with the D</i>	All Restrooms
Wall			
Field - 6"x6"	Dal-Tile Arctic White - Semi-Gloss 0190		All Restrooms
Accent - 1"x6"	Dal-Tile Arctic White - Liner 0190		All Restrooms
Accent - 6"x6"	Dal-Tile Arctic White - Matte 0790		All Restrooms
Grout			
Grout	Dal-Tile New Taupe - Poly-Blend 185		All Restrooms
Shall Partitions			
Shall Partitions	Bobrick Sierra Forest Green SC04		All Restrooms
Fixtures			
Fixtures	Mfg. TBD - Pure White		All Restrooms
Accessories			
Accessories	Per District Specs - Brushed Chrome		All Restrooms

6.4. Bay Friendly Stop Waste Checklist

Bay-Friendly Landscape Plan Review		
Bay-Friendly Practice	Pts.	Comments
1. Landscape Locally		
1.1 Evaluate climate, exposure and topography.		
<input type="checkbox"/> Submit the completed Bay-Friendly Site Analysis Form.	5	
1.2 Assess the soil and test drainage.		
<input type="checkbox"/> Submit laboratory soil analysis results and recommendations for organic soil amendments and fertilizers.	5	
1.4 Consider the potential for fire		
<input type="checkbox"/> For sites adjacent to fire sensitive open space or wildlands only: Submit a Fire Mitigation Plan that identifies: adjacent fire sensitive wildland or open space or developments; exposure to prevailing winds during the dry season; steep slopes, especially south and west facing that can increase wind speed and convey heat; vegetation type, particularly species that burn readily. Specify mitigations to the above identified fire vectors including the establishment of a 'defensible zone' immediately surrounding the structure that uses one or more strategies for fireescaping, such as: <ul style="list-style-type: none"> • Emphasize plants with low fuel volume and/or high moisture content in planting plan. Avoid plants with high oil content or that tend to accumulate excessive dead wood or debris (pyrophites). • Trees are well spaced and pruned to 6 feet minimum above ground; dense shrub plantings are separate from trees to minimize fuel ladders. • Trees and tall shrubs planted where limbs and branches will not reach the building or grow under overhangs as they mature. • Fine shredded bark mulch is avoided. • Decks are faced and constructed out of fire resistant materials. 	5	
2. Landscape for Less to the Landfill		
2.1a-c Select appropriate plants: choose & locate plants to grow to natural size and avoid shearing.		
<input type="checkbox"/> No species will require shearing. (Required)	R	
<input type="checkbox"/> Plants specified can grow to mature size within space allotted them.	1	
<input type="checkbox"/> Over-planting and tight spacing of long term plants (increased density of plants for rapid fill) is avoided.	1	
2.1d Select appropriate plants: do not plant invasive species.		
<input type="checkbox"/> None of the species listed by Cal-IPC as invasive in the San Francisco Bay Area are included in the planting plan. (Required)	R	
2.2a Keep plant debris on site: Grasscycle (ongoing basis).		
<input type="checkbox"/> Maintenance specifications and/or manual include grasscycling (grass clippings left on the lawn after mowing) for all lawns from April through October, or longer. Sports turf may be excluded "in season" when clippings will interfere with play.	2	

APPENDIX

6.5. Plant List

RECOMMENDED PLANTS

The mission of the landscape palette is to combine the existing campus landscape with a newly proposed plant palette.

A site inventory was conducted to collect the names of all the existing species on site. In addition, existing building and school colors on campus were selected and incorporated into this palette, unifying the entire campus.

Plant goals included, hardy, pest free, low maintenance plants that are tolerant of poor soils and abuse. Species with drought tolerance, seasonal color, and deer resistance were carefully researched and compared to the existing plants on campus. Many evergreen species were also a goal and added where possible. Protecting existing landmark and historic trees is a high priority on campus and was matched by adding additional iconic species, including several native plants.

Trees	Botanical Name	Common Name
	<i>Acer palmatum</i>	Japanese Maple
	<i>Acer rubrum</i> 'Armstrong'	Armstrong Maple
	<i>Acer rubrum</i> 'October Glory'	October Glory Maple
	<i>Aesculus carnea</i> 'Briotti'	Red Horsechestnut
	<i>Arbutus unedo</i> 'Elfin King'	Strawberry Tree
	<i>Arbutus</i> 'Marina'	Marina Strawberry Tree
	<i>Brahea edulis</i>	Guadalupe Palm
	<i>Carpinus betulus</i> 'Fastigiata'	European Hornbeam
	<i>Casuarina littoralis stricta</i>	She-Oak
	<i>Ceanothus</i> 'Ray Hartman'	Wild Lilac
	<i>Cedrus atlantica</i>	Atlas Cedar
	<i>Cedrus deodara</i>	Deodar Cedar
	<i>Celtis australis</i>	European Hackberry
	<i>Cercis canadensis</i>	Eastern Redbud
	<i>Cercis occidentalis</i>	Western Redbud
	<i>Ceratonia siliqua</i>	Carob Tree
	<i>Chamaecyparis lawsoniana</i>	Lawson Cedar
	<i>Chionanthus retusus</i>	Chinese Fringe Tree
	<i>Cornus kousa</i>	Korean Dogwood
	<i>Fraxinus angustifolia</i> 'Raywood'	Raywood Ash
	<i>Fraxinus uhdei</i>	Evergreen Ash
	<i>Fremontodendron californicum</i>	Flannel Bush
	<i>Geijera parvifolia</i>	Australian Willow
	<i>Ginkgo biloba</i> 'Autumn Gold'	Autumn Gold Ginkgo
	<i>Heteromeles arbutifolia</i>	Toyon
	<i>Koelreuteria bipinnata</i>	Chinese Flame Tree
	<i>Koelreuteria paniculata</i>	GoldenRain Tree
	<i>Laurus x</i> 'Saratoga'	Hybrid Laurel
	<i>Leptospermum scoparium</i> 'Horizontalis', 'Pink Cascade', 'Snow White'	New Zealand Tea Tree
	<i>Lophostemon confertus</i>	Brisbane Box
	<i>Magnolia grandiflora</i> 'Russet', 'St. Mary', 'Little Gem'	Southern Magnolia
	<i>Magnolia x soulangeana</i> 'Alba'	Saucer Magnolia
	<i>Malus floribunda</i>	Japanese Flowering Crabapple
	<i>Maytenus boaria</i>	Mayten

Trees	Botanical Name	Common Name	RECOMMENDED PLANTS
	Melaleuca linariifolia	Flaxleaf Paperbark	
	Melaleuca nesophila	Pink Melaleuca	
	Melaleuca quinquenervia	Cajeput Tree	
	Melaleuca styphelioides	Prickly Paperbark	
	Metrosideros excelus	New Zealand Christmas Tree	
	Nyssa sylvatica	Tupelo	
	Olea europaea	Olive	
	Palms sp.	Palms	
	Phoenix dactylifera	Date Palm	
	Pistacia chinensis	Chinese Pistache	
	Platanus acerifolia 'Yarwood', 'Columbia'	London Plane Tree	
	Podocarpus gracilior	Fern Pine	
	Populus fremontii 'Nevada'	Western Cottonwood	
	Populus nigra 'Italica'	Lombardy Poplar	
	Prunus cerasifera 'Krauter Vesuvius'	Flowering Plum	
	Pyrus calleryana 'Chanticleer', 'Aristocrat'	Flowering Pear	
	Quercus agrifolia	Coast Live Oak	
	Quercus rubra	Red Oak	
	Quercus suber	Cork Oak	
	Sapium sebiferum	Chinese Tallow	
	Schinus molle	California Pepper Tree	
	Sequoia sempervirens 'Soquel'	Redwood	
	Sophora japonica 'Regent'	Scholar Tree	
	Tibouchina urvilleana	Princess Flower	
	Tilia cordata	Little Leaf Linden	
	Tristaniopsis laurina	Swamp Myrtle	
	Ulmus parvifolia	Chinese Elm	
	Washingtonia robusta	Mexican Fan Palm	
	Xylosa congestum	Xylosma	
	Zelkova serrata 'Musashino'	Musashino Columnar Zelkova	

APPENDIX

6.5. Plant List

RECOMMENDED PLANTS

Shrubs/Perennials	Botanical Name	Common Name
	<i>Abelia x grandiflora</i>	Glossy Abelia
	<i>Agapanthus orientalis</i> 'Dark Star', 'Peter Pan', 'Queen Anne'	Lily-of-the-Nile
	<i>Arbutus unedo</i> 'Compacta'	Dwarf Strawberry Tree
	<i>Arctostaphylos densiflora</i> 'Howard McMinn'	Manzanita
	<i>Aucuba japonica</i> 'Variegata'	Japanese Aucuba
	<i>Berberis thunbergii</i>	Japanese Barberry
	<i>Berberis darwinii</i>	Darwin Barberry
	<i>Calycanthus occidentalis</i>	Spice Bush
	<i>Camellia hiemalis</i>	Camellia
	<i>Camellia sasanqua</i>	Camellia
	<i>Carpenteria californica</i>	Bush Anemone
	<i>Ceanothus arboreus</i> 'Concha'	Wild Lilac
	<i>Ceanothus griseus</i> var. <i>horizontalis</i> 'Carmel Creeper'	Carmel Creeper
	<i>Ceratostigma plumbaginoides</i>	Dwarf Plumbago
	<i>Cistus salviifolius</i>	Sageleaf Rockrose
	<i>Cistus</i> 'Doris Hibberson', <i>C. ladanifer</i> , <i>C. purpureus</i>	Rockrose
	<i>Coleonema album</i>	White Diosma
	<i>Coleonema pulchrum</i>	Pink Diosma
	<i>Convolvulus mauritanicus</i>	Blue Shrub Morning Glory
	<i>Coprosma repens</i> 'Coppershine'	Coprosma
	<i>Dietes bicolor</i> , <i>D. iridioides</i> , <i>D. vegeta</i>	Fortnight Lily
	<i>Dodonaea viscosa</i> 'Purpurea'	Hopseed Bush
	<i>Echium fastuosum</i>	Pride of Madeira
	<i>Eriogonum arborescens</i>	Santa Cruz Island Buckwheat
	<i>Eriogonum grande</i> var. <i>rubescens</i>	Red Buckwheat
	<i>Eriogonum umbellatum</i>	Sulfur Buckwheat
	<i>Erysimum</i> 'Bowles Mauve'	Wallflower
	<i>Escallonia</i> 'Fradesii', 'Newport Dwarf'	Escallonia
	<i>Euonymus japonicus/fortunei</i>	Evergreen Euonymus
	<i>Fatsia japonica</i>	Japanese Aralia
	<i>Garrya elliptica</i>	Coast Silktassel
	<i>Grevillea lavandulacea</i> 'Noellii', 'Constance'	Lavender Grevillea
	<i>Grevillea rosmarinifolia</i>	Rosemary Grevillea
	<i>Helichrysum petiolare</i> 'Limelight'	Licorice Plant

Shrubs/Perennials	Botanical Name	Common Name	RECOMMENDED PLANTS
	'Variegatum'		
	Hemerocallis hybrids	Evergreen Daylilly	
	Lavandula angustifolia 'Hidcote', 'Munstead'	English Lavender	
	Laurus nobilis	Sweet Bay	
	Leonotis leonurus	Lion's Tail	
	Leptospermum scoparium 'Horizontalis', 'Pink Cascade', 'Snow White', 'Ruby Glow'	New Zealand Tea Tree	
	Ligustrum japonicum 'Texanum'	Japanese Privet	
	Limonium perezii	Sea Lavender	
	Loropetalum chinense	Loropetalum	
	Mahonia repens	Creeping Mahonia	
	Myrtus communis	Myrtle	
	Nandina domestica 'Harbor Dwarf', 'Gulf Stream', 'Compacta'	Heavenly Bamboo	
	Nephrolepis cordifolia	Southern Sword Fern	
	Phlomis fruticosa	Jerusalem Sage	
	Phormium sp.	New Zealand Flax	
	Pittosporum crassifolium	Pittosporum	
	Pittosporum tobira 'Variegata', 'Wheeleri'	Japanese Mock Orange	
	Polystichum munitum	Western Swordfern	
	Rhamnus californica 'Eve Case'	Coffeeberry	
	Rhapiolepis indica 'Clara', 'Ballerina', 'Enchantress'	Indian Hawthorn	
	Ribes sanguineum	Flowering Currant	
	Romneya coulteri	Matilija Poppy	
	Rosa sp.	Flowering Carpet Rose	
	Rosmarinus officinalis 'Arp', 'Blue Boy', 'Prostratus', 'Irene'	Rosemary	
	Salvia leucantha	Mexican Bush Sage	
	Salvia greggii	Autumn Sage	
	Sarcococca hookerana humilis	Sweet Box	
	Viburnum tinus 'Dwarf'	Laurustinus Dwarf	
	Ternstroemia gymnathera	Ternstroemia	
	Teucrium fruticans 'Compactum'	Bush Germander	
	Vaccinium ovatum	Evergreen Huckleberry	
	Westringia fruticosa	Coast Rosemary	
	Woodwardia fimbriata	Giant Chain Fern	

APPENDIX

6.5. Plant List

RECOMMENDED PLANTS

Grasses	Botanical Name	Common Name
	Carex buchananii	Leather Leaf Sedge
	Carex flacca, C. glauca	Blue Sedge
	Helictotrichon sempervirens	Blue Oat Grass
	Pennisetum setaceum 'Rubrum'	Fountain Grass
	Stipa arundinacea	Feather Grass
Groundcover	Botanical Name	Common Name
	Arctostaphylos 'Emerald Carpet'	Manzanita
	Baccharis pilularis	Dwarf Coyote Brush
	Chamaemelum nobile	Chamomile
	Coprosma x kirkii	Coprosma
	Erigeron karvinskianus	Fleabane
	Fragaria chiloensis	Sand Strawberry
	Gazania hybrids	Gazania
	Hypericum patulum 'Hidcote'	Saint Johnswort
	Lantana montevidensis, L. sellowiana	Lantana
	Liriope muscari	Lily Turf
	Myoporum parvifolium	Myoporum
	Ophiopogon japonicus	Mondo Grass
	Pratia pedunculata	Blue Star Creeper
	Sollya heterophylla	Australian Bluebell Creeper
	Thymus vulgaris, T. serpyllum, T. pseudolanuginosus	Creeping Thyme
	Trachelospermum asiaticum	Jasmine
	Tracehlopermum jasminoides	Star Jasmine
	Vinca minor	
	Dwarf Periwinkle	

Native Plants	Botanical Name	Common Name	RECOMMENDED PLANTS
<p>Note: When working within the creek area, a biologist should be consulted for the appropriate native species.</p>	Aesculus californica	California Buckeye	
	Alnus rhombifolia	White Alder	
	Briza minor	Little Quaking Grass	
	Ceanothus griseus var. horizontalis	Wild Lilac	
	Cephalanthus occidentalis	Button Bush	
	Cercis occidentalis	Western Redbud	
	Erigeron glaucus	Beach Aster	
	Fragaria chiloensis	Sand Strawberry	
	Fremontodendron californicum	Flannel Bush	
	Garrya 'James Roof'	Silk Tassel	
	Heteromeles arbutifolia	Toyon	
	Hordeum brachyantherum	Meadow Barley	
	Iris douglasiana	Douglas Iris	
	Juncus patens	California Gray	
	Juncus xiphioides	Juncus	
	Lyonothamnus floribundus	Catalina Ironwood	
	Mentha arvensis	Mint	
Mimulus guttatus	Monkey Flower		
Pleuropogon californicus	California Semaphore Grass		
Potentilla pacifica	Cinquefoil		
Quercus agrifolia	Coast Live Oak		
Ranunculus muricatus	Spiny Buttercup		
Rhamnus californica	Coffeeberry		
Rosa californica	California Rose		
Salix laevigata	Red Willow		

APPENDIX

6.6. Vallier Exterior Signage Package

SIGNAGE STANDARDS

program
manufacturer
color palette
proportion
font family
icons
sign types

Sample ASI Modulex Messenger Series Signs: Exterior

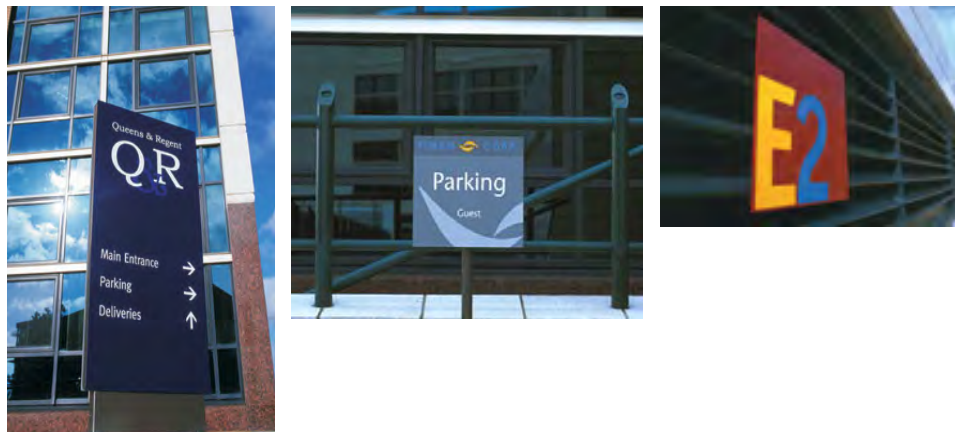

Sample ASI Modulex Messenger Series Signs: Interior

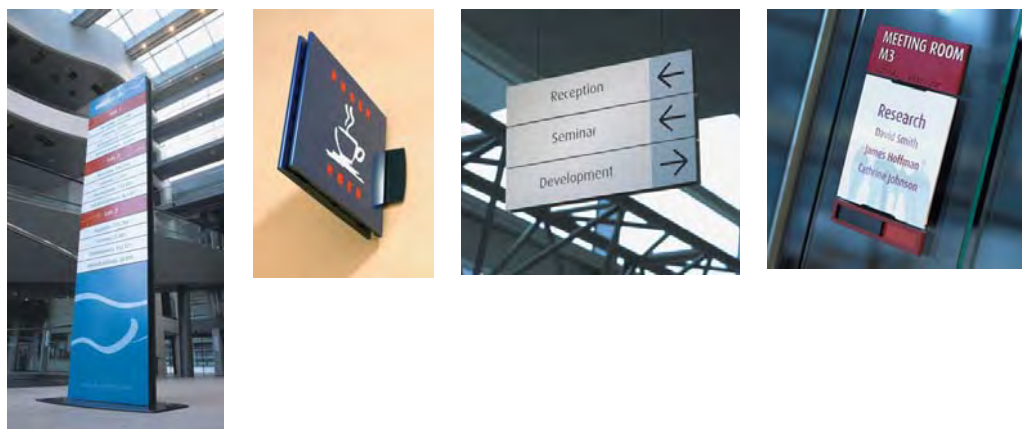

MANUFACTURER

During the sign manufacturer selection process, five companies were considered. West Coast Signworks, a local company, and KVO Industries, a manufacturer of porcelain enamel signs, were considered but not selected due to limited sign type options and highly specialized services. Three modular sign manufacturers were interviewed: ASI Modulex, Forms & Surfaces, and Corporate Sign Systems. ASI Modulex was selected as the Contra Costa Community College District standard based on cost, product range, and the opportunity to establish coordinated standards for the District's three colleges.

ASI Modulex's Messenger series has been selected as the Contra Costa College campus standard sign system. The Messenger series is a modular flat panel system appropriate for both interior and exterior uses.

- Versatile, expandable, modular system
- Single or double-sided
- Front-loading interchangeable aluminum panels
- Standard three year limited warranty

APPENDIX

6.6. Vallier Exterior Signage Package

COLOR PALETTE

Four colors from the ASI Modulex standard color charts have been selected as standards for Contra Costa College. These colors reflect the College's school colors and the brick red prevalent on campus.





Typical campus signs will have two colors, a background color and a font/image color. An accent color may be added. Campus signs may not contain more than three colors with the exception of complex graphics such as the campus map.

The Americans with Disabilities Act Accessibility Guidelines recommends a minimum 70% Light Reflectance Value (LRV) contrast between sign text and background colors.

The combinations at right indicate code compliant and non-compliant combinations. See the Sign Types section for standard and alternative combinations for interior and exterior signs.

The samples shown here are approximations of the colors identified and should not be used for selecting a sign color.

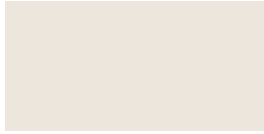
See the sample board for actual samples.

			
Midnite Blue SC-603 LRV 6 CMYK 100-72-0-32	Wine SC-224 LRV 6 CMYK 75-100-70-15	Bone SC-922 LRV 73 CMYK 0-2-6-7	Modulex 07 LRV 33 CMYK 0-0-0-44

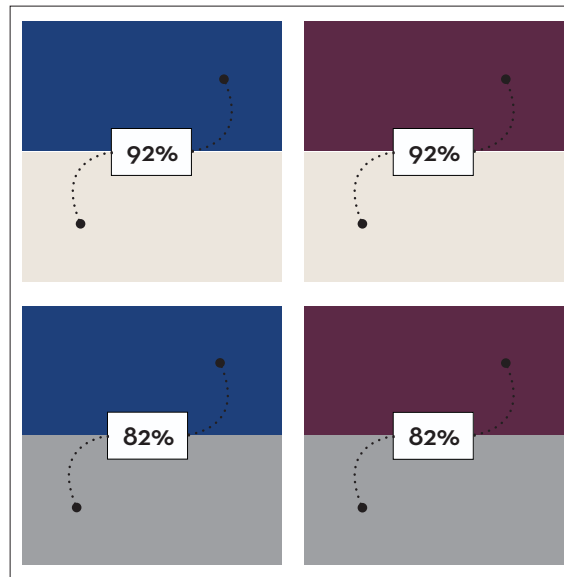

These color combinations are ADA compliant. See Exterior Color and Interior Color sections for standard combinations.

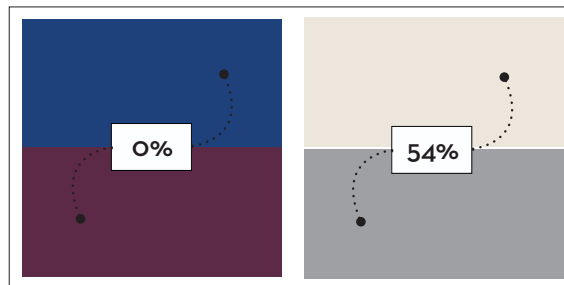

These color combinations are not ADA compliant and should not be used.

Proportion Range

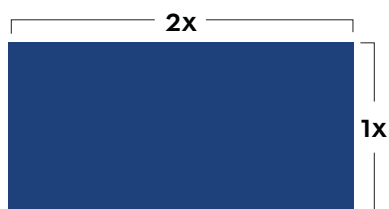

1:2 Proportion

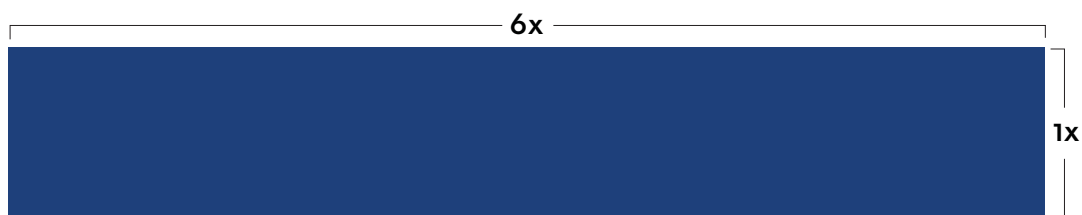

1:6 Proportion

PROPORTION

The Contra Costa College Campus is characterized by broad open spaces and generally horizontal architecture. The sign system integrates with this character by maintaining a horizontal format and balanced proportions.

The ASI Modulex Messenger Series signage system is very adaptable and is available in a range of dimensions. In order to maintain a consistent look throughout the Contra Costa College campus while accommodating the appropriate sign content, campus sign proportions may range from 1:2 to 1:6. Signs of the same type, e.g. Interior Directional signs, should all be of the same proportion. See the Sign Types section for specific details.

APPENDIX

6.6. Vallier Exterior Signage Package

FONT FAMILY

The Neutraface font family produced by House Industries is the standard font for the Contra Costa College campus. This font family is central to the campus signage system and is currently being used in College print publications and on the College website.

The samples at left indicate the individual fonts used within the campus signage system. See the Sign Types section for standard fonts for interior and exterior signs.

College Identification

CONTRA COSTA COLLEGE

Neutraface Display TT - Bold

Building Identification

ADMINISTRATION

Neutraface Display TT - Medium

Wayfinding (Destination Identification)

PARKING

Neutraface Text TT - Demi

Room Numbers

108

Neutraface Display TT - Titling

Descriptive Text

Student parking lots are Lots 1, 4, 5, 7, 9 and 10.

Neutraface Text TT - Book

Selected Informational Icons: Identify campus services and destinations



Standard Shape



Telephone



Bus Stop



Restaurant



Information

Selected Regulatory Icons: Identify prohibited activities



Standard Shape



No Smoking



No Access



No Eating or
Drinking



No Parking/
No Motorized Vehicles

Selected Hazard Warning Icons: Identify hazardous conditions and materials



Standard Shape



Biohazard

Selected Code Required Icons: Shape and placement as required by law



Access



Restroom



Hearing Loss

ICONS

Contra Costa College is a multi-cultural, multi-lingual campus. In order to facilitate clear communication, a system of icons has been developed and shall be integrated with campus signage.

To increase the clarity of communication, each icon is associated with a boundary shape indicating the type of information being conveyed. Informational icons identify services and destination located on campus. Regulatory icons identify required or prohibited behavior. Hazard icons locate hazardous materials and locations. Code required icons are those required by law, typically for ADA access identification and are to be display as required by law.

APPENDIX

6.6. Vallier Exterior Signage Package

SYSTEM ELEMENTS

The sign system standards are applied to a hierarchy of sign types. Each sign type serves a unique function in guiding visitors across the campus from the front door of the campus to the door of each individual room. Proposed sign types include:

Exterior Signs

- Gateway
- Vehicular Wayfinding
- Pedestrian Gateway
- Pedestrian Wayfinding
- Campus Map
- Building Identification
- Regulatory Signage

Interior Signs

- Building Directory
- Building Wayfinding
- Service Identification
- Room Identification
- Code Signage

These sign types are grouped into exterior signs and interior signs, with distinct standards for each group. In addition, standards have been or are being developed for each sign type.

Wayfinding & Informational Signage: Dark Background with Light Graphics/Text

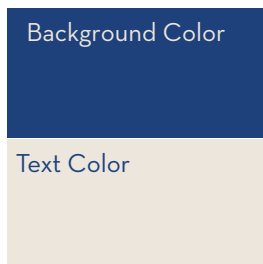

Standard Combination
Midnite Blue SC-603
Bone SC-922

Regulatory & Hazard Signage: Light Background with Dark Graphics/Text

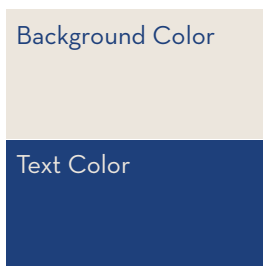

Standard Combination
Bone SC-922
Midnite Blue SC-603

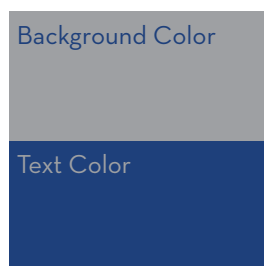

Alternative Combination
Modulex 07
Midnite Blue SC-603

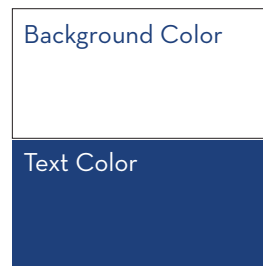

Alternative Combination
Use only where a white reflective surface is required.
White CMYK 0-0-0-0
Midnite Blue SC-603

EXTERIOR SIGNS

Exterior signs have been assigned a distinct color combination to establish a strong, consistent presence on campus. Directional and Informational signs guide campus visitors from the surrounding environment onto and through the campus. Regulatory and Hazard signs establish the rules for navigating the campus.

The Wayfinding sign designs shown in this section are placeholders only. The Contra Costa College Signage System graphics will be developed as part of a separate Wayfinding Master Plan process.

APPENDIX

6.6. Vallier Exterior Signage Package

GATEWAY SIGN

Gateway signs establish Contra Costa College's presence within the City of San Pablo and identify entries to the campus.

The sign design shown here is a sample only. The Contra Costa College Signage System graphics will be developed as part of a separate Wayfinding Master Plan process.

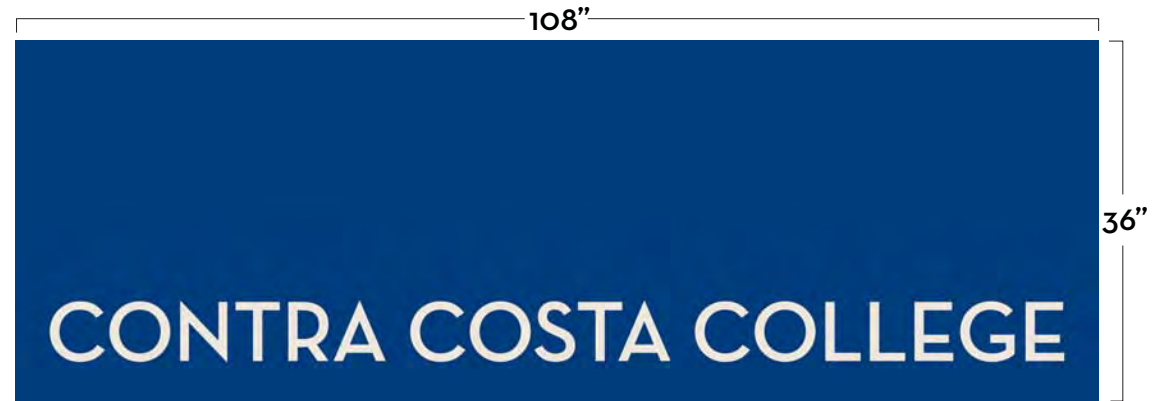

VEHICULAR WAYFINDING

Vehicular Wayfinding signs help drivers navigate to the parking lot closest to their destination.

The sign design shown here is a sample only. The Contra Costa College Signage System graphics will be developed as part of a separate Wayfinding Master Plan process.

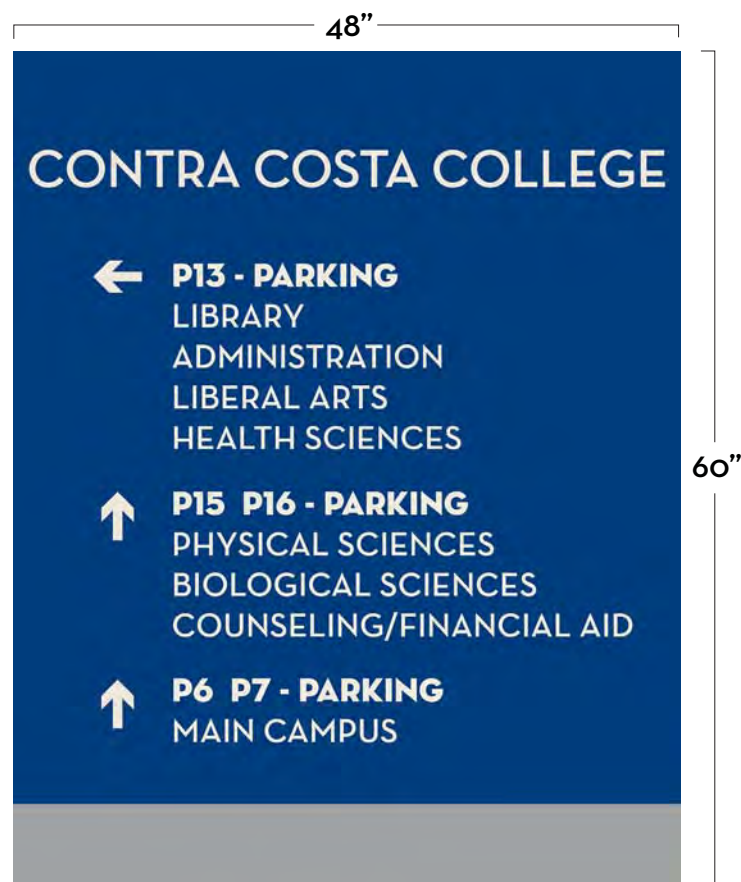

APPENDIX

6.6. Vallier Exterior Signage Package

PEDESTRIAN GATEWAY

Pedestrian Gateway signs welcome visitors to campus and provide directions to destinations on campus.

The sign design shown here is a sample only. The Contra Costa College Signage System graphics will be developed as part of a separate Wayfinding Master Plan process.



PEDESTRIAN WAYFINDING

Pedestrian Wayfinding signs and Campus Maps provide a directional network throughout the campus, guiding visitors to their destinations.

The sign design shown here is a sample only. The Contra Costa College Signage System graphics will be developed as part of a separate Wayfinding Master Plan process.

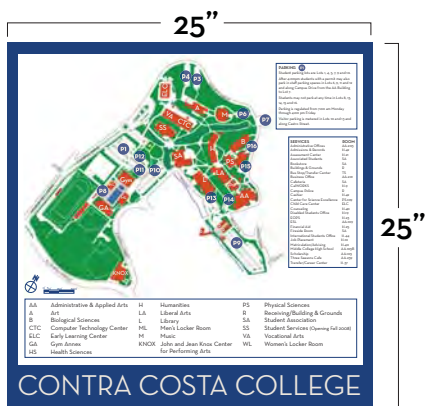

A standard case and stand will be specified for the campus map

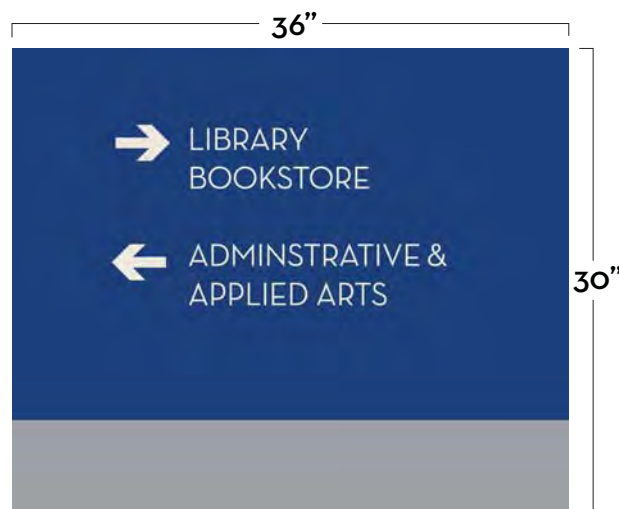

APPENDIX

6.6. Vallier Exterior Signage Package

BUILDING IDENTIFICATION

Building Identification signs identify each building and are to be placed on the building at the main building entries and where necessary to identify the building from adjacent cross campus paths.

Satin Aluminum is the College standard finish. Every effort should be made to ensure adequate contrast between the aluminum color and the building color at all sign locations. The College may choose to approve the use of one of the alternate colors under special conditions.

LETTER STYLE:

12" [STUDENT 12" SERVICES]

Letters: ASI Modulex LPS Series Solid Plate Aluminum Cut Dimensional Letters

Size: 12" High x 1/2" Thick

Font: Neutraface Display TT Medium, 12" between words

Finish: See below for options, ensure contrast with building color.

Mounting: Concealed Stud Mount

LETTER FINISH: Ensure contrast with building color



Standard:
Aluminum, Satin Finish



Alternate:
Midnite Blue SC-603
Baked Enamel or Painted



Alternate:
Wine SC-224
Baked Enamel or Painted

LETTER PLACEMENT: Ensure visibility from circulation paths

Standard to be developed

Regulatory & Hazard Signage: Light Background with Dark Graphics/Text

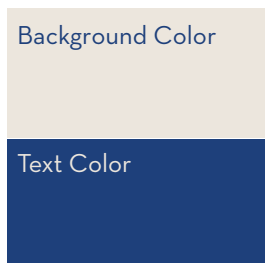

Standard Combination
Bone SC-922
Midnite Blue SC-603

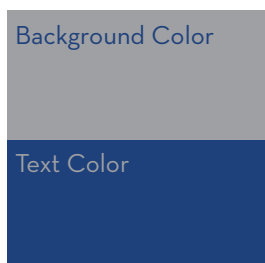

Alternative Combination
Modulex 07
Midnite Blue SC-603

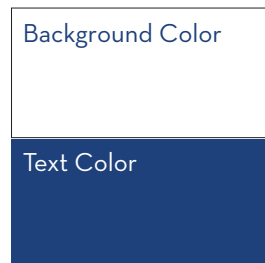

Alternative Combination
White CMYK 0-0-0-0
Midnite Blue SC-603
Use only where a white reflective surface is required.

REGULATORY SIGNS

Regulatory Signage is developed on an as needed basis. The standard proportion is 1:2 for these signs.

All pole-mounted signs shall be in-ground mounted.

Sample Sign:



APPENDIX

6.7. Vallier Exterior Building Color Standards

EXTERIOR BUILDING COLORS

The standard exterior building colors are the result of an effort to simplify and consolidate paint colors for the campus.

The palette was developed by inventorying all existing paint colors on campus, grouping the existing colors by color family, and selecting a single color to represent each color family. The resulting contemporary color palette complements the existing, and not easily changed, brick and natural colored concrete while accommodating future renovation and new construction.

The samples shown here are approximations of the colors identified and should not be used for selecting a building palette. See the sample board for actual samples.

Primary Body Colors



Kelly Moore 06-100sp



Kelly Moore 06-101sp



Kelly Moore 06-102sp

Secondary Body Colors



Kelly Moore 06-103sp



Kelly Moore 06-104sp



Kelly Moore 06-105sp

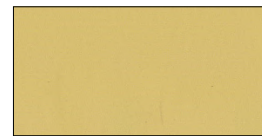

Kelly Moore 06-106sp

Primary Accent Color

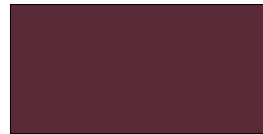

Kelly Moore 06-107sp

Secondary Accent Colors

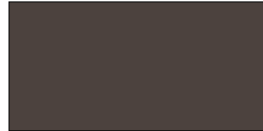

Kelly Moore 06-108sp



Kelly Moore 06-109sp

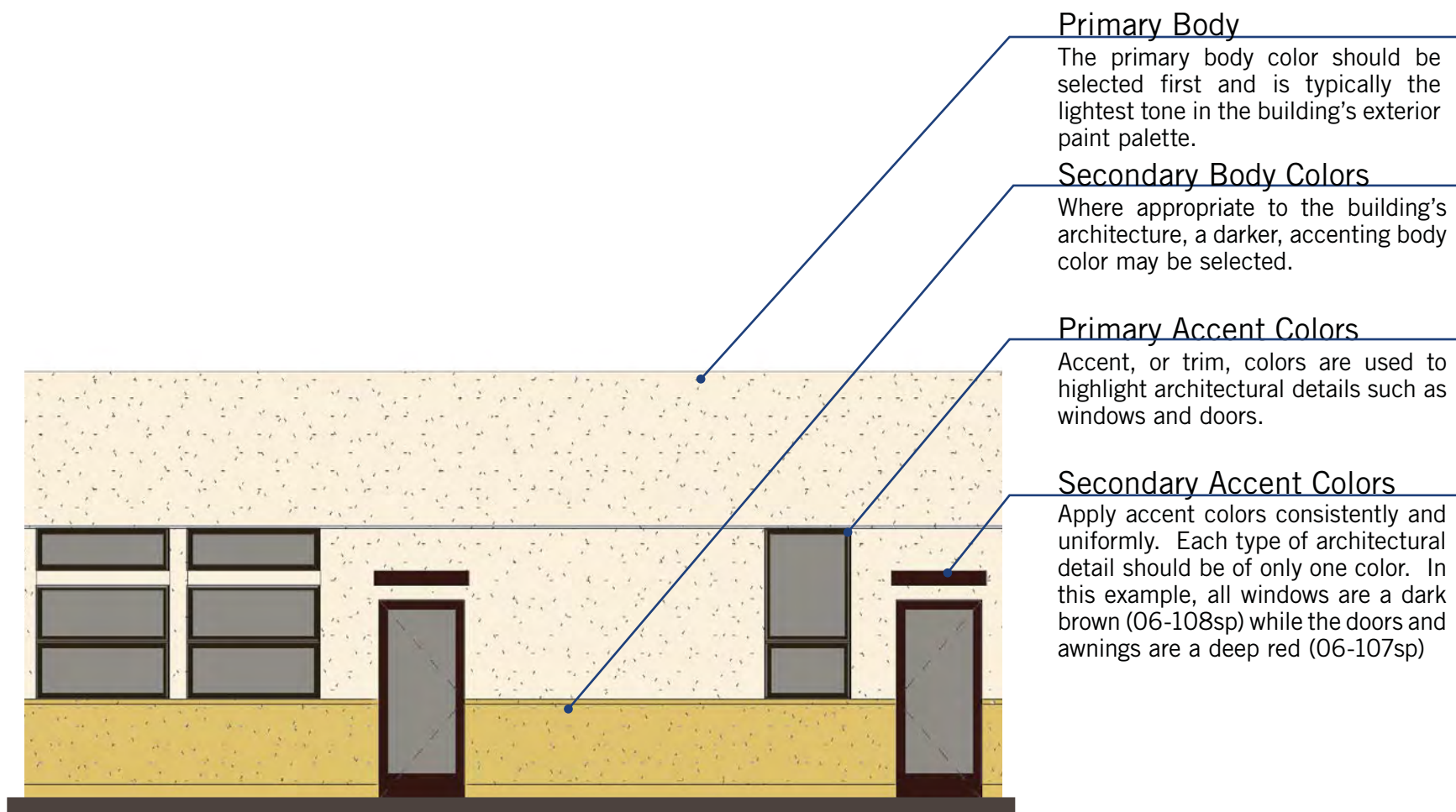

Primary Body

The primary body color should be selected first and is typically the lightest tone in the building's exterior paint palette.

Secondary Body Colors

Where appropriate to the building's architecture, a darker, accenting body color may be selected.

Primary Accent Colors

Accent, or trim, colors are used to highlight architectural details such as windows and doors.

Secondary Accent Colors

Apply accent colors consistently and uniformly. Each type of architectural detail should be of only one color. In this example, all windows are a dark brown (06-108sp) while the doors and awnings are a deep red (06-107sp)

APPENDIX

6.8. LEED™ Project Checklist v2



LEED for New Construction v2.2 Registered Project Checklist

Project Name:
Project Address:

Yes	?	No	Sustainable Sites		14 Points
<input type="checkbox"/>	<input type="checkbox"/>	<input type="checkbox"/>			

<input checked="" type="checkbox"/>	<input type="checkbox"/>	<input type="checkbox"/>	Prereq 1	Construction Activity Pollution Prevention	Required
<input type="checkbox"/>	<input type="checkbox"/>	<input type="checkbox"/>	Credit 1	Site Selection	1
<input type="checkbox"/>	<input type="checkbox"/>	<input type="checkbox"/>	Credit 2	Development Density & Community Connectivity	1
<input type="checkbox"/>	<input type="checkbox"/>	<input type="checkbox"/>	Credit 3	Brownfield Redevelopment	1
<input type="checkbox"/>	<input type="checkbox"/>	<input type="checkbox"/>	Credit 4.1	Alternative Transportation, Public Transportation Access	1
<input type="checkbox"/>	<input type="checkbox"/>	<input type="checkbox"/>	Credit 4.2	Alternative Transportation, Bicycle Storage & Changing Rooms	1
<input type="checkbox"/>	<input type="checkbox"/>	<input type="checkbox"/>	Credit 4.3	Alternative Transportation, Low-Emitting & Fuel-Efficient Vehicles	1
<input type="checkbox"/>	<input type="checkbox"/>	<input type="checkbox"/>	Credit 4.4	Alternative Transportation, Parking Capacity	1
<input type="checkbox"/>	<input type="checkbox"/>	<input type="checkbox"/>	Credit 5.1	Site Development, Protect or Restore Habitat	1
<input type="checkbox"/>	<input type="checkbox"/>	<input type="checkbox"/>	Credit 5.2	Site Development, Maximize Open Space	1
<input type="checkbox"/>	<input type="checkbox"/>	<input type="checkbox"/>	Credit 6.1	Stormwater Design, Quantity Control	1
<input type="checkbox"/>	<input type="checkbox"/>	<input type="checkbox"/>	Credit 6.2	Stormwater Design, Quality Control	1
<input type="checkbox"/>	<input type="checkbox"/>	<input type="checkbox"/>	Credit 7.1	Heat Island Effect, Non-Roof	1
<input type="checkbox"/>	<input type="checkbox"/>	<input type="checkbox"/>	Credit 7.2	Heat Island Effect, Roof	1
<input type="checkbox"/>	<input type="checkbox"/>	<input type="checkbox"/>	Credit 8	Light Pollution Reduction	1

Yes	?	No	Water Efficiency		5 Points
<input type="checkbox"/>	<input type="checkbox"/>	<input type="checkbox"/>			

<input type="checkbox"/>	<input type="checkbox"/>	<input type="checkbox"/>	Credit 1.1	Water Efficient Landscaping, Reduce by 50%	1
<input type="checkbox"/>	<input type="checkbox"/>	<input type="checkbox"/>	Credit 1.2	Water Efficient Landscaping, No Potable Use or No Irrigation	1
<input type="checkbox"/>	<input type="checkbox"/>	<input type="checkbox"/>	Credit 2	Innovative Wastewater Technologies	1
<input type="checkbox"/>	<input type="checkbox"/>	<input type="checkbox"/>	Credit 3.1	Water Use Reduction, 20% Reduction	1
<input type="checkbox"/>	<input type="checkbox"/>	<input type="checkbox"/>	Credit 3.2	Water Use Reduction, 30% Reduction	1

			Energy & Atmosphere		17 Points
<input type="checkbox"/>	<input type="checkbox"/>	<input type="checkbox"/>			

<input checked="" type="checkbox"/>	<input type="checkbox"/>	<input type="checkbox"/>	Prereq 1	Fundamental Commissioning of the Building Energy Systems	Required
<input checked="" type="checkbox"/>	<input type="checkbox"/>	<input type="checkbox"/>	Prereq 2	Minimum Energy Performance	Required
<input checked="" type="checkbox"/>	<input type="checkbox"/>	<input type="checkbox"/>	Prereq 3	Fundamental Refrigerant Management	Required
<input type="checkbox"/>	<input type="checkbox"/>	<input type="checkbox"/>	Credit 1	Optimize Energy Performance	1 to 10
<input type="checkbox"/>	<input type="checkbox"/>	<input type="checkbox"/>		10.5% New Buildings or 3.5% Existing Building Renovations	1
<input type="checkbox"/>	<input type="checkbox"/>	<input type="checkbox"/>		14% New Buildings or 7% Existing Building Renovations	2
<input type="checkbox"/>	<input type="checkbox"/>	<input type="checkbox"/>		17.5% New Buildings or 10.5% Existing Building Renovations	3
<input type="checkbox"/>	<input type="checkbox"/>	<input type="checkbox"/>		21% New Buildings or 14% Existing Building Renovations	4
<input type="checkbox"/>	<input type="checkbox"/>	<input type="checkbox"/>		24.5% New Buildings or 17.5% Existing Building Renovations	5
<input type="checkbox"/>	<input type="checkbox"/>	<input type="checkbox"/>		28% New Buildings or 21% Existing Building Renovations	6
<input type="checkbox"/>	<input type="checkbox"/>	<input type="checkbox"/>		31.5% New Buildings or 24.5% Existing Building Renovations	7
<input type="checkbox"/>	<input type="checkbox"/>	<input type="checkbox"/>		35% New Buildings or 28% Existing Building Renovations	8
<input type="checkbox"/>	<input type="checkbox"/>	<input type="checkbox"/>		38.5% New Buildings or 31.5% Existing Building Renovations	9
<input type="checkbox"/>	<input type="checkbox"/>	<input type="checkbox"/>		42% New Buildings or 35% Existing Building Renovations	10
<input type="checkbox"/>	<input type="checkbox"/>	<input type="checkbox"/>	Credit 2	On-Site Renewable Energy	1 to 3
<input type="checkbox"/>	<input type="checkbox"/>	<input type="checkbox"/>		2.5% Renewable Energy	1
<input type="checkbox"/>	<input type="checkbox"/>	<input type="checkbox"/>		7.5% Renewable Energy	2
<input type="checkbox"/>	<input type="checkbox"/>	<input type="checkbox"/>		12.5% Renewable Energy	3
<input type="checkbox"/>	<input type="checkbox"/>	<input type="checkbox"/>	Credit 3	Enhanced Commissioning	1
<input type="checkbox"/>	<input type="checkbox"/>	<input type="checkbox"/>	Credit 4	Enhanced Refrigerant Management	1
<input type="checkbox"/>	<input type="checkbox"/>	<input type="checkbox"/>	Credit 5	Measurement & Verification	1
<input type="checkbox"/>	<input type="checkbox"/>	<input type="checkbox"/>	Credit 6	Green Power	1

Yes	?	No	Materials & Resources		13 Points
<input type="checkbox"/>	<input type="checkbox"/>	<input type="checkbox"/>			

<input checked="" type="checkbox"/>	<input type="checkbox"/>	<input type="checkbox"/>	Prereq 1	Storage & Collection of Recyclables	Required
<input type="checkbox"/>	<input type="checkbox"/>	<input type="checkbox"/>	Credit 1.1	Building Reuse, Maintain 75% of Existing Walls, Floors & Roof	1
<input type="checkbox"/>	<input type="checkbox"/>	<input type="checkbox"/>	Credit 1.2	Building Reuse, Maintain 100% of Existing Walls, Floors & Roof	1
<input type="checkbox"/>	<input type="checkbox"/>	<input type="checkbox"/>	Credit 1.3	Building Reuse, Maintain 50% of Interior Non-Structural Elements	1
<input type="checkbox"/>	<input type="checkbox"/>	<input type="checkbox"/>	Credit 2.1	Construction Waste Management, Divert 50% from Disposal	1
<input type="checkbox"/>	<input type="checkbox"/>	<input type="checkbox"/>	Credit 2.2	Construction Waste Management, Divert 75% from Disposal	1
<input type="checkbox"/>	<input type="checkbox"/>	<input type="checkbox"/>	Credit 3.1	Materials Reuse, 5%	1
<input type="checkbox"/>	<input type="checkbox"/>	<input type="checkbox"/>	Credit 3.2	Materials Reuse, 10%	1
<input type="checkbox"/>	<input type="checkbox"/>	<input type="checkbox"/>	Credit 4.1	Recycled Content, 10% (post-consumer + ½ pre-consumer)	1
<input type="checkbox"/>	<input type="checkbox"/>	<input type="checkbox"/>	Credit 4.2	Recycled Content, 20% (post-consumer + ½ pre-consumer)	1
<input type="checkbox"/>	<input type="checkbox"/>	<input type="checkbox"/>	Credit 5.1	Regional Materials, 10% Extracted, Processed & Manufactured Regional	1
<input type="checkbox"/>	<input type="checkbox"/>	<input type="checkbox"/>	Credit 5.2	Regional Materials, 20% Extracted, Processed & Manufactured Regional	1
<input type="checkbox"/>	<input type="checkbox"/>	<input type="checkbox"/>	Credit 6	Rapidly Renewable Materials	1
<input type="checkbox"/>	<input type="checkbox"/>	<input type="checkbox"/>	Credit 7	Certified Wood	1

Yes	?	No	Indoor Environmental Quality		15 Points
<input type="checkbox"/>	<input type="checkbox"/>	<input type="checkbox"/>			

<input checked="" type="checkbox"/>	<input type="checkbox"/>	<input type="checkbox"/>	Prereq 1	Minimum IAQ Performance	Required
<input checked="" type="checkbox"/>	<input type="checkbox"/>	<input type="checkbox"/>	Prereq 2	Environmental Tobacco Smoke (ETS) Control	Required
<input type="checkbox"/>	<input type="checkbox"/>	<input type="checkbox"/>	Credit 1	Outdoor Air Delivery Monitoring	1
<input type="checkbox"/>	<input type="checkbox"/>	<input type="checkbox"/>	Credit 2	Increased Ventilation	1
<input type="checkbox"/>	<input type="checkbox"/>	<input type="checkbox"/>	Credit 3.1	Construction IAQ Management Plan, During Construction	1
<input type="checkbox"/>	<input type="checkbox"/>	<input type="checkbox"/>	Credit 3.2	Construction IAQ Management Plan, Before Occupancy	1
<input type="checkbox"/>	<input type="checkbox"/>	<input type="checkbox"/>	Credit 4.1	Low-Emitting Materials, Adhesives & Sealants	1
<input type="checkbox"/>	<input type="checkbox"/>	<input type="checkbox"/>	Credit 4.2	Low-Emitting Materials, Paints & Coatings	1
<input type="checkbox"/>	<input type="checkbox"/>	<input type="checkbox"/>	Credit 4.3	Low-Emitting Materials, Carpet Systems	1
<input type="checkbox"/>	<input type="checkbox"/>	<input type="checkbox"/>	Credit 4.4	Low-Emitting Materials, Composite Wood & Agrifiber Products	1
<input type="checkbox"/>	<input type="checkbox"/>	<input type="checkbox"/>	Credit 5	Indoor Chemical & Pollutant Source Control	1
<input type="checkbox"/>	<input type="checkbox"/>	<input type="checkbox"/>	Credit 6.1	Controllability of Systems, Lighting	1
<input type="checkbox"/>	<input type="checkbox"/>	<input type="checkbox"/>	Credit 6.2	Controllability of Systems, Thermal Comfort	1
<input type="checkbox"/>	<input type="checkbox"/>	<input type="checkbox"/>	Credit 7.1	Thermal Comfort, Design	1
<input type="checkbox"/>	<input type="checkbox"/>	<input type="checkbox"/>	Credit 7.2	Thermal Comfort, Verification	1
<input type="checkbox"/>	<input type="checkbox"/>	<input type="checkbox"/>	Credit 8.1	Daylight & Views, Daylight 75% of Spaces	1
<input type="checkbox"/>	<input type="checkbox"/>	<input type="checkbox"/>	Credit 8.2	Daylight & Views, Views for 90% of Spaces	1

Yes	?	No	Innovation & Design Process		5 Points
<input type="checkbox"/>	<input type="checkbox"/>	<input type="checkbox"/>			

<input type="checkbox"/>	<input type="checkbox"/>	<input type="checkbox"/>	Credit 1.1	Innovation in Design: Provide Specific Title	1
<input type="checkbox"/>	<input type="checkbox"/>	<input type="checkbox"/>	Credit 1.2	Innovation in Design: Provide Specific Title	1
<input type="checkbox"/>	<input type="checkbox"/>	<input type="checkbox"/>	Credit 1.3	Innovation in Design: Provide Specific Title	1
<input type="checkbox"/>	<input type="checkbox"/>	<input type="checkbox"/>	Credit 1.4	Innovation in Design: Provide Specific Title	1
<input type="checkbox"/>	<input type="checkbox"/>	<input type="checkbox"/>	Credit 2	LEED® Accredited Professional	1

Yes	?	No	Project Totals (pre-certification estimates)		69 Points
<input type="checkbox"/>	<input type="checkbox"/>	<input type="checkbox"/>			

Certified: 26-32 points, Silver: 33-38 points, Gold: 39-51 points, Platinum: 52-69 points

185 Berry Street
Lobby One, Suite 5100
San Francisco, California 94107
415.856.3000 phone
415.856.3001 fax
www.perkinswill.com

PERKINS
+ WILL